

ROMAN[®]
REFINED SHOWERING

40th
ANNIVERSARY
FOUNDED 1985

Design Guide

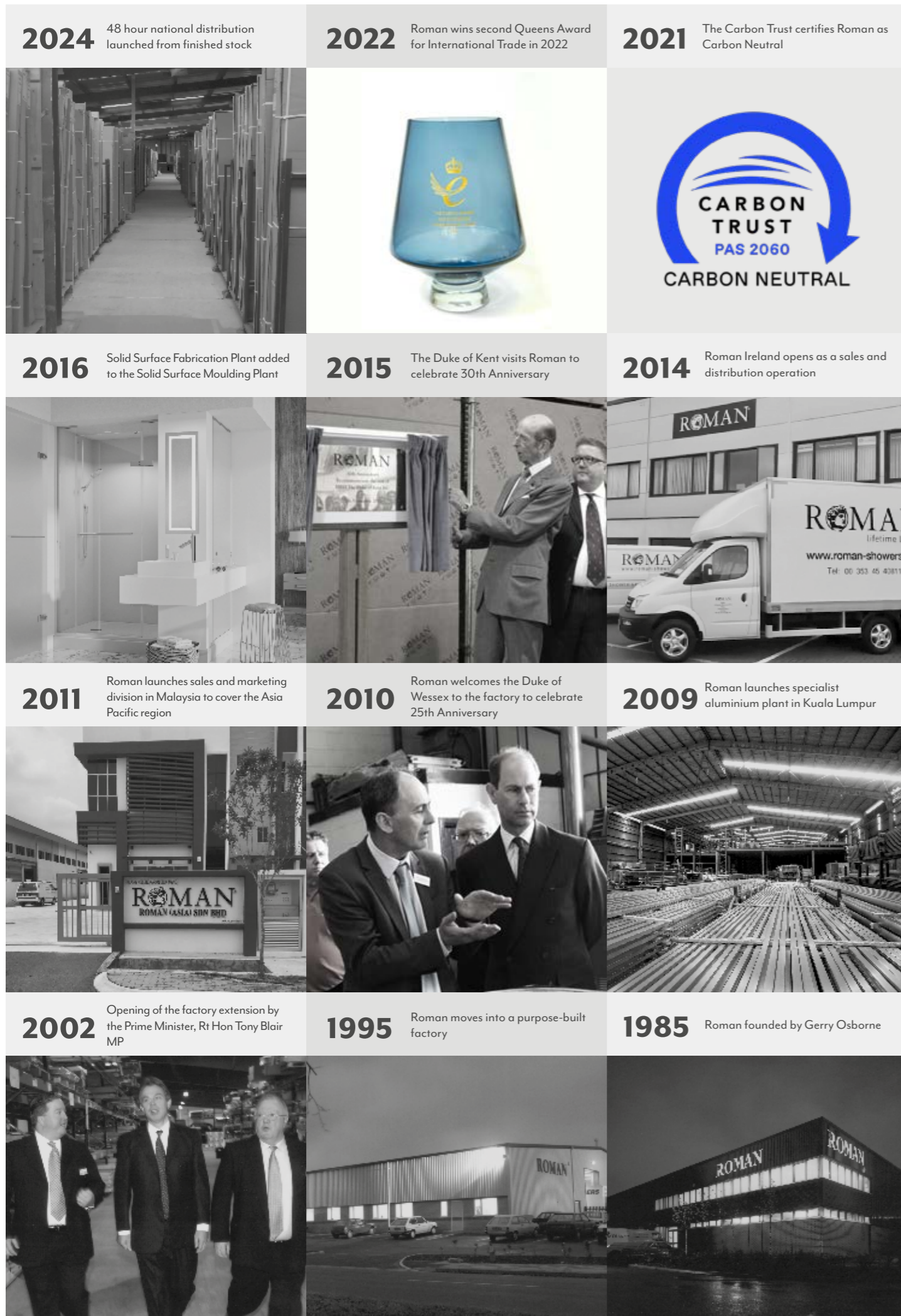



Colours 08

Liberty 28

Innov8 60

Embrace 80

Haven8 86

Haven6 92

Haven Framed 102

Wetroom Panels 106

Shower Trays 132

Bath Screens 142

Vanity Units 157

Mirrors 158

Accessories 159



At the heart of Roman is the desire to be the best.

It is Roman's vision to lead and innovate in the Showering industry. To design and manufacture top quality inspirational showering solutions, which offers choice for all markets.

To expertly manufacture our products in Britain, so they are designed and built to last and offer a lifetime of effortless showering for all. It is our aim to give all our customers exceptional value and service; this ethos runs throughout the culture of the business and cannot be imitated.

We have been certified as Carbon Neutral and we will constantly strive to further improve and enhance our environmental impact.

WHO WE ARE

Roman has been designing and manufacturing showering solutions for 40 years, and is home to the UK's largest shower manufacturing plant. All Roman products are designed and created in Britain, offering the ultimate in quality, precision and craftsmanship. Roman's diverse and versatile collection of products encompasses something for every style and shape bathroom – no matter what the budget. Roman is a reputable and well established UK Brand, supplying showering products to 72 International markets.



In-house customer support network



Highest Quality Materials



Nationwide Technical Service representatives

40 YEARS OF
UK DESIGN & MANUFACTURING
EXCELLENCE

GROWTH ACROSS
72 INTERNATIONAL
MARKETS



Roman Stone Shower Trays are inherently Anti-Slip, carrying the highest national standard of DIN Class C



Innovation & exceptional product design

Award Winning

Manufacturing & Innovation

Our products and ranges have won multiple awards including The Queens Award for Enterprise - International Trade, in 2017 and again in 2022.

We have also been identified as one of London Stock Exchange's 1000 Companies to Inspire Britain. We are extremely proud to be recognised as one of the UK's fastest growing and most dynamic small and medium sized businesses.

Roman is included in the FT1000, which is the list of Europe's Fastest Growing Companies, compiled by the Financial Times. We have also been awarded the Bathroom Safety Compliance Award 2018 by the NHIC.



Winner of Best Bathroom Product of the Year



Winner of The Queen's Awards for Enterprise: International Trade



Winner of the Bathroom Manufacturer Association Circular Economy Award November 2021



Winner of Best Bathroom Product of the Year



Trust

Buy with Confidence

All Roman products are designed and created in the UK, offering the ultimate in quality, precision and craftsmanship. All Roman's manufacturing processes are carried out at our UK Manufacturing Plant and Headquarters and meet and exceed approved UK and European testing standards.

For complete peace of mind, all Roman Shower Enclosures, Wetroom Panels and Bath Screens are accompanied by a fully service backed Truelife Lifetime Guarantee.



Products Designed for All



All products are tested to EN14428



Toughened safety glass



All products offer exceptional levels of style and performance

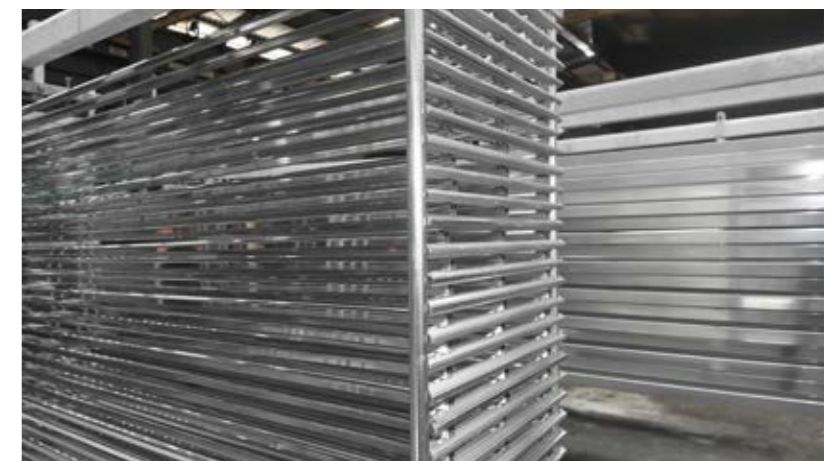

Aluminium used is light, strong and requires minimal maintenance



Colours

Collection

The Roman Colours range showcases Roman's design and manufacturing capability in a way that no range has before. Design in the international hotel sector has demanded new finishes and metal colour options to be developed and the Colours range brings this development and expertise into the retail market for the first time.

The mechanisms within Colours elevate showering to a new level and achieve the genuine soft close experience for the very first time, leading the way in superior bathroom design.





Polished Chrome



Polished Gold Optic



Brushed Black Chrome



Brushed Chrome



Brushed Gold Optic



Polished Black Chrome



Polished Nickel



Polished Brass



Matt White



Brushed Nickel



Brushed Brass





The Colours sliding door is available in all key sizes and offers a straightforward bespoke service for non-standard sizes. Side panels are also available in all key sizes and through the bespoke service. The sliding mechanism elevates showering to a new level achieving a genuine soft close, leading the way in superior bathroom design.



Winner of Best Bathroom Product of the Year

Sliding Door

Features & Benefits

- Soft Close
- Quick release door function for easy cleaning
- Barrier free entry option
- Silent and ultra-smooth running roller bearing system
- Beautifully styled corner joints
- Compatible trays available
- Available in 11 colour finishes

Technical Information

Glass Thickness: 10mm
Total Height: 2005mm
Handing: Left or Right handing must be specified when ordering



Colour options for hardware

 Brushed Black Chrome add BBL to Codes	 Polished Black Chrome add PBL to Codes	 Brushed Chrome add BCR to Codes	 Polished Chrome add PCR to Codes	 Brushed Brass add BBR to Codes	 Polished Brass add PBR to Codes
 Brushed Nickel add BNI to Codes	 Polished Nickel add PNI to Codes	 Brushed Gold Optic add BGO to Codes	 Polished Gold Optic add PGO to Codes	 Matt White add MWH to Codes	

Sliding Door Alcove Fitting - Brushed Nickel
 Right Hand, Door Code: CSL008BNI



Corner Fitting

Size (mm)	Handing	Adjustment Door & In-Line (mm)	Adjustment Side Panel (mm)	Aperture (mm)	Door Code	Side Panel Code
1200 x 800	Left Hand	1173 - 1187	773 - 787	495	CSL009	CP005
1200 x 800	Right Hand	1173 - 1187	773 - 787	495	CSL010	CP006
1200 x 900	Left Hand	1173 - 1187	873 - 887	495	CSL009	CP007
1200 x 900	Right Hand	1173 - 1187	873 - 887	495	CSL010	CP008
1400 x 800	Left Hand	1373 - 1387	773 - 787	595	CSL011	CP005
1400 x 800	Right Hand	1373 - 1387	773 - 787	595	CSL012	CP006
1400 x 900	Left Hand	1373 - 1387	873 - 887	595	CSL011	CP007
1400 x 900	Right Hand	1373 - 1387	873 - 887	595	CSL012	CP008
1500 x 800	Left Hand	1473 - 1487	773 - 787	645	CSL013	CP005
1500 x 800	Right Hand	1473 - 1487	773 - 787	645	CSL014	CP006
1500 x 900	Left Hand	1473 - 1487	873 - 887	645	CSL013	CP007
1500 x 900	Right Hand	1473 - 1487	873 - 887	645	CSL014	CP008
1700 x 800	Left Hand	1673 - 1687	773 - 787	745	CSL015	CP005
1700 x 800	Right Hand	1673 - 1687	773 - 787	745	CSL016	CP006
1700 x 900	Left Hand	1673 - 1687	873 - 887	745	CSL015	CP007
1700 x 900	Right Hand	1673 - 1687	873 - 887	745	CSL016	CP008

Alcove Fitting

Size (mm)	Handing	Adjustment Door & In-Line (mm)	Aperture (mm)	Door Code
1200	Left Hand	1166 - 1194	495	CSL001
1200	Right Hand	1166 - 1194	495	CSL002
1400	Left Hand	1366 - 1394	595	CSL003
1400	Right Hand	1366 - 1394	595	CSL004
1500	Left Hand	1466 - 1494	645	CSL005
1500	Right Hand	1466 - 1494	645	CSL006
1700	Left Hand	1666 - 1694	745	CSL007
1700	Right Hand	1666 - 1694	745	CSL008





The hinged doors are available in a choice of 10 metal finishes. The aluminium wall joints are engineered to provide water integrity while ensuring a clean and seamless appearance. Every option comes with the intricate Roman dam system, which blends into the wall profile and below the door to ensure complete water integrity for these frameless enclosures.

Hinged Door *with In-line Panel*

Features & Benefits

- Soft Close
- Hinged from wall
- New clear and minimal seals
- New minimal easy fix wall profile system
- Integrated 'tray or floor' Water Safe System
- Designed for installation to straight vertical walls
- Available in 10 colour finishes

Technical Information

Glass Thickness: 10mm

Total Height: 2000mm

Handing: Left or Right handing must be specified when ordering



Colour options for hardware

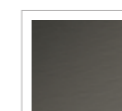

Brushed Black Chrome
add BBL to Codes

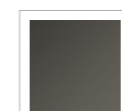

Polished Black Chrome
add PBL to Codes

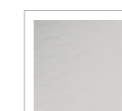

Brushed Chrome
add BCR to Codes

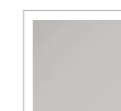

Polished Chrome
add PCR to Codes

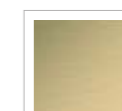

Brushed Brass
add BBR to Codes

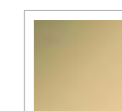

Polished Brass
add PBR to Codes



Brushed Nickel
add BNI to Codes

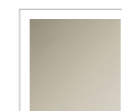

Polished Nickel
add PNI to Codes

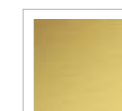

Brushed Gold Optic
add BGO to Codes

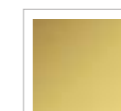

Polished Gold Optic
add PGO to Codes



Corner Fitting

Size (mm)	Handing	Adjustment (mm)	Aperture (mm)	Door Code	In-Line Panel Code	Side Panel Code
1000 x 800	Left Hand	773-787	620	CD001	CI009	CP001
1000 x 800	Right Hand	773-787	620	CD001	CI010	CP002
1000 x 900	Left Hand	873-887	620	CD001	CI009	CP003
1000 x 900	Right Hand	873-887	620	CD001	CI010	CP004
1200 x 800	Left Hand	773-787	620	CD001	CI011	CP001
1200 x 800	Right Hand	773-787	620	CD001	CI012	CP002
1200 x 900	Left Hand	873-887	620	CD001	CI011	CP003
1200 x 900	Right Hand	873-887	620	CD001	CI012	CP004
1400 x 800	Left Hand	773-787	620	CD001	CI013	CP001
1400 x 800	Right Hand	773-787	620	CD001	CI014	CP002
1400 x 900	Left Hand	873-887	620	CD001	CI013	CP003
1400 x 900	Right Hand	873-887	620	CD001	CI014	CP004
1600 x 800	Left Hand	773-787	620	CD001	CI015	CP001
1600 x 800	Right Hand	773-787	620	CD001	CI016	CP002
1600 x 900	Left Hand	873-887	620	CD001	CI015	CP003
1600 x 900	Right Hand	873-887	620	CD001	CI016	CP004

Alcove Fitting

Size (mm)	Handing	Adjustment (mm)	Aperture (mm)	Door Code	In-Line Panel Code
1000	Left Hand	973 - 987	620	CD001	CI001
1000	Right Hand	973 - 987	620	CD001	CI002
1200	Left Hand	1173 - 1187	620	CD001	CI003
1200	Right Hand	1173 - 1187	620	CD001	CI004
1400	Left Hand	1373 - 1387	620	CD001	CI005
1400	Right Hand	1373 - 1387	620	CD001	CI006
1600	Left Hand	1573 - 1587	620	CD001	CI007
1600	Right Hand	1573 - 1587	620	CD001	CI008

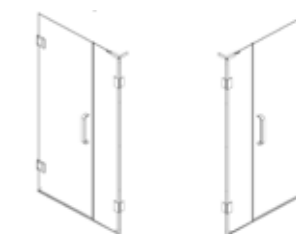

Alcove Left Hand

Alcove Right Hand

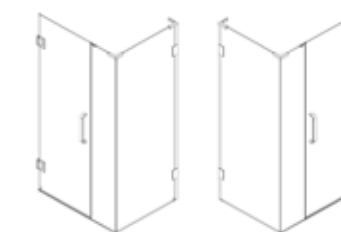

Corner Left Hand

Corner Right Hand



Some larger design configurations may wish to centralise the door or simply move it away from wall fixing. The Colours range has integrated such glass to glass fixing options into their range – both for corner and alcove configurations. The Roman dam system adapts to link the wall fixing beneath the glass and door to give complete water integrity.

Hinged Door *with Two In-line Panel*

Features & Benefits

- Soft Close
- Hinged from wall
- New clear and minimal seals
- New minimal easy fix wall profile system
- Integrated 'tray or floor' Water Safe System
- Designed for installation to straight vertical walls
- Outward opening only
- Available in 10 colour finishes

Technical Information

Glass Thickness: 10mm

Total Height: 2000mm

Handing: Left or Right handing must be specified when ordering

Softclose
Soft cushioned close system

Colour options for hardware

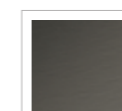

Brushed Black Chrome
add BBL to Codes

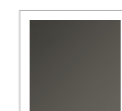

Polished Black Chrome
add PBL to Codes

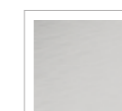

Brushed Chrome
add BCR to Codes

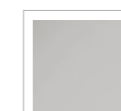

Polished Chrome
add PCR to Codes

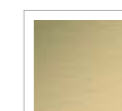

Brushed Brass
add BBR to Codes

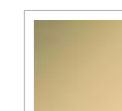

Polished Brass
add PBR to Codes



Brushed Nickel
add BNI to Codes

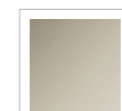

Polished Nickel
add PNI to Codes

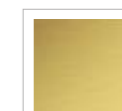

Brushed Gold Optic
add BGO to Codes

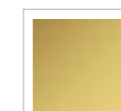

Polished Gold Optic
add PGO to Codes



Corner Fitting

Size (mm)	Handing	Adjustment Door & In-line (mm)	Adjustment Side Panel (mm)	Aperture (mm)	Door Code	In-Line Panel Code	Side Panel Code
1200 x 800	Left Hand	1164 - 1178	773 - 787	625	CD002	CI020	CP001
1200 x 800	Right Hand	1164 - 1178	773 - 787	625	CD002	CI021	CP002
1200 x 900	Left Hand	1164 - 1178	873 - 887	625	CD002	CI020	CP003
1200 x 900	Right Hand	1164 - 1178	873 - 887	625	CD002	CI021	CP004
1400 x 800	Left Hand	1364 - 1378	773 - 787	625	CD002	CI022	CP001
1400 x 800	Right Hand	1364 - 1378	773 - 787	625	CD002	CI023	CP002
1400 x 900	Left Hand	1364 - 1378	873 - 887	625	CD002	CI022	CP003
1400 x 900	Right Hand	1364 - 1378	873 - 887	625	CD002	CI023	CP004
1600 x 800	Left Hand	1564 - 1578	773 - 787	625	CD002	CI024	CP001
1600 x 800	Right Hand	1564 - 1578	773 - 787	625	CD002	CI025	CP002
1600 x 900	Left Hand	1564 - 1578	873 - 887	625	CD002	CI024	CP003
1600 x 900	Right Hand	1564 - 1578	873 - 887	625	CD002	CI025	CP004

Alcove Fitting

Size (mm)	Adjustment (mm)	Aperture (mm)	Door Code	In-Line Panel Code
1200	1166 - 1194	625	CD002	CI017
1400	1366 - 1394	625	CD002	CI018
1600	1566 - 1594	625	CD002	CI019



Hinged Door with Two In-Line Panel Corner Fitting - Polished Gold Optic
 Left Hand, Door Code: CD002PGO, In-Line Panel code: CI024PGO, Side Panel code: CP001PGO



There are a large number of side panel options to complete the design – with precisely colour matched bracing systems to complete the look and give complete rigidity to the largest of bathroom designs.

Wetroom Panels *with Deflector Panel*

Features & Benefits

- Compatible trays available
- Available in 11 colour finishes
- Additional deflector panel moves the wet area into the shower tray.

Technical Information

Glass Thickness: 10mm

Total Height: 2000mm

Handing: Left or Right handing must be specified when ordering

Panels & Brace Bars

Size (mm)	Description	Handing	Adjustment (mm)	Code
800	Wetroom Panel	Left Hand	+/- 7.5 mm	CW001
800	Wetroom Panel	Right Hand	+/- 7.5 mm	CW002
900	Wetroom Panel	Left Hand	+/- 7.5 mm	CW003
900	Wetroom Panel	Right Hand	+/- 7.5 mm	CW004
1000	Wetroom Panel	Left Hand	+/- 7.5 mm	CW005
1000	Wetroom Panel	Right Hand	+/- 7.5 mm	CW006
1200	Wetroom Panel	Left Hand	+/- 7.5 mm	CW007
1200	Wetroom Panel	Right Hand	+/- 7.5 mm	CW008
300	Pivoting Deflector Panel	–	–	CPM001
1030	Brace Kit Straight and 45°	–	Cut to suit	C4590SQ
1000	Side Panel Bracing Kit	–	Cut to suit	CT90SQ
1030	Low Level Bracing Kit Ceiling	–	Cut to suit	CC50SQ

Colour options for hardware





Bath screen - Brushed Brass
Right Hand, Door Code: CS0001BBR

Bath Screen

Features & Benefits

- Soft Close
- Outward opening only
- Handing must be specified

Technical Information

Glass Thickness: 10mm
Total Height: 1600mm
Handing: Left or Right handing must be specified when ordering

Sizes

Size (mm)	Handing	Adjustment (mm)	Code
1011	Left Hand	998 - 1012	CS001
1011	Right Hand	998 - 1012	CS002



Soft cushioned close system

Colour options for hardware

Brushed Black Chrome add BBL to Codes	Polished Black Chrome add PBL to Codes	Brushed Chrome add BCR to Codes	Polished Chrome add PCR to Codes	Brushed Brass add BBR to Codes	Polished Brass add PBR to Codes	Brushed Nickel add BNI to Codes	Polished Nickel add PNI to Codes	Brushed Gold Optic add BGO to Codes	Polished Gold Optic add PGO to Codes



Liberty

Frameless Collection

The Liberty Collection is freed from the shackles of traditional bathroom design, with its ultra-modern and minimalist focus.

The leading range really does offer endless design and solution options. The Liberty Sliding door system offers a genuine soft close system for the first time in shower enclosures. The secret lies hidden behind a plate inside the top rail. A heavy gauge spring system is activated when the 10mm or 8mm thick door is moving and the last 50mm of door movement, opening or closing, is taken over by the soft close system and it slowly, quietly, and elegantly takes the door to its destination.

The system itself is tested over 20,000 cycles and will control the door regardless of speed you open or close it.

Please note:

The minimalist nature of the product means if the shower head is directed at seal and component interfaces, some water may escape from the showering area. The product will perform as intended under normal showering conditions.



Sliding Door *with Fluted Glass*

Features & Benefits

- Soft Close
- Quick release door function for easy cleaning
- Barrier free entry option
- Silent and ultra-smooth running roller bearing system
- Choice of colour finishes available
- Beautifully styled corner joints
- Compatible trays available
- Matt Black sandblast finish renders product essentially scratch-proof

Technical Information

Glass Thickness: 8mm

Total Height: 2000mm

Handing: Left or Right handing must be specified when ordering

Corner Fitting

Size (mm)	Handing	Adjustment (mm)	Door Code	Side Panel Code
1200 x 800	Left Hand	1173 - 1187 & 773 - 787	KT1D12FLC	KTR1C8FL
1200 x 800	Right Hand	1173 - 1187 & 773 - 787	KT1D12FRC	KTR1C8FR
1200 x 900	Left Hand	1173 - 1187 & 873 - 887	KT1D12FLC	KTR1C9FL
1200 x 900	Right Hand	1173 - 1187 & 873 - 887	KT1D12FRC	KTR1C9FR

Alcove Fitting

Size (mm)	Handing	Adjustment (mm)	Code
1200	Left Hand	1166 - 1194	KT1D12FL
1200	Right Hand	1166 - 1194	KT1D12FR

Softclose
Soft cushioned close system

Colour options for hardware

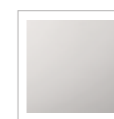

Polished Chrome
add **S** to Codes

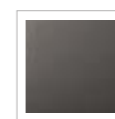

Matt Black
add **B** to Codes

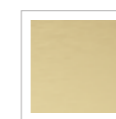

Brushed Brass
add **BR** to Codes

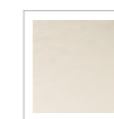

Brushed Nickel
add **N** to Codes

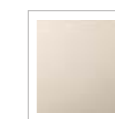

Polished Nickel
add **PN** to Codes

Please note:

Liberty corner products are designed to be installed onto Roman standard trays and wet room floors. In the case of a tray installation; the tiles must not encroach the tray apron by more than **10mm**. The adjustment range stated is the min-max product size.



1200 x 800 Corner Fitting - Polished Nickel with Fluted Glass
Right Hand Sliding Door and Side Panel: KT1D12FRCPN and KTR1C8FRPN
Anti-Slip Tray: RSTC126



1200 Alcove Fitting - Brushed Nickel
 Right Hand Door: KT1D12RN
 Anti-Slip Tray: RSTG128, Shower Basket: RSB05BR

Sliding Door with Clear Glass

Features & Benefits



- Soft Close
- Quick release door function for easy cleaning
- Barrier free entry option
- Silent and ultra-smooth running roller bearing system
- Choice of colour finishes available
- Beautifully styled corner joints
- Compatible trays available
- Matt Black sandblast finish renders product essentially scratch-proof

Technical Information

Glass Thickness: 8mm, 10mm
Total Height: 2000mm
Handing: Left or Right handing must be specified when ordering

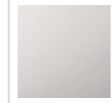
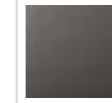

Colour options for hardware

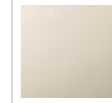
				
Polished Chrome add S to Codes	Matt Black add B to Codes	Brushed Brass add BR to Codes	Brushed Nickel add N to Codes	Polished Nickel add PN to Codes

1700 x 800 Corner Fitting - Matt Black
 Right Hand Door and Side Panel: KT1D17RCB and KTR1C8B
 Anti-Slip Tray: RSTG178 Shower Basket: RSB05B



1700 x 800 Corner Fitting - Brushed Brass
 Right Hand Door and Side Panel: KT1D17RCBR and KTR1C8BR
 Anti-Slip Tray: RSTG178 Shower Basket: RSB05B

Corner Fitting

Size (mm)	Glass Thickness	Adjustment (mm)	Door Code Left Hand	Door Code Right Hand	Side Panel Code
1200 x 800	8mm	1173 - 1187 & 773 - 787	KT1D12LC	KT1D12RC	KTR1C8
1200 x 900	8mm	1173 - 1187 & 873 - 887	KT1D12LC	KT1D12RC	KTR1C9
1400 x 800	8mm	1373 - 1387 & 773 - 787	KT1D14LC	KT1D14RC	KTR1C8
1400 x 900	8mm	1373 - 1387 & 873 - 887	KT1D14LC	KT1D14RC	KTR1C9
1500 x 800	8mm	1473 - 1487 & 773 - 787	KT1D15LC	KT1D15RC	KTR1C8
1500 x 900	8mm	1473 - 1487 & 873 - 887	KT1D15LC	KT1D15RC	KTR1C9
1700 x 800	8mm	1673 - 1687 & 773 - 787	KT1D17LC	KT1D17RC	KTR1C8
1700 x 900	8mm	1673 - 1687 & 873 - 887	KT1D17LC	KT1D17RC	KTR1C9

Size (mm)	Glass Thickness	Adjustment (mm)	Door Code Left Hand	Door Code Right Hand	Side Panel Code
1200 x 800	10mm	1173 - 1187 & 773 - 787	TT1D12LC	TT1D12RC	TTR1C8
1200 x 900	10mm	1173 - 1187 & 873 - 887	TT1D12LC	TT1D12RC	TTR1C9
1400 x 800	10mm	1373 - 1387 & 773 - 787	TT1D14LC	TT1D14RC	TTR1C8
1400 x 900	10mm	1373 - 1387 & 873 - 887	TT1D14LC	TT1D14RC	TTR1C9
1500 x 800	10mm	1473 - 1487 & 773 - 787	TT1D15LC	TT1D15RC	TTR1C8
1500 x 900	10mm	1473 - 1487 & 873 - 887	TT1D15LC	TT1D15RC	TTR1C9
1700 x 800	10mm	1673 - 1687 & 773 - 787	TT1D17LC	TT1D17RC	TTR1C8
1700 x 900	10mm	1673 - 1687 & 873 - 887	TT1D17LC	TT1D17RC	TTR1C9

Alcove Fitting

Size (mm)	Glass Thickness	Adjustment (mm)	Code Left Hand	Code Right Hand
1200	8mm	1166 - 1194	KT1D12L	KT1D12R
1400	8mm	1366 - 1394	KT1D14L	KT1D14R
1500	8mm	1466 - 1494	KT1D15L	KT1D15R
1700	8mm	1666 - 1694	KT1D17L	KT1D17R

Size (mm)	Glass Thickness	Adjustment (mm)	Code Left Hand	Code Right Hand
1200	10mm	1166 - 1194	TT1D12L	TT1D12R
1400	10mm	1366 - 1394	TT1D14L	TT1D14R
1500	10mm	1466 - 1494	TT1D15L	TT1D15R
1700	10mm	1666 - 1694	TT1D17L	TT1D17R

Softclose
 Soft cushioned close system

Please note:

Liberty corner products are designed to be installed onto Roman standard trays and wet room floors. In the case of a tray installation; the tiles must not encroach the tray apron by more than 10mm. The adjustment range stated is the min-max product size.



900 Alcove Fitting - Polished Chrome
Hinged Door: KL913S
Anti-Slip Tray: RSTG90 Shower Basket: RSB03

Hinged Door *with Clear Glass*

Features & Benefits

- Hinged from wall
- New clear and minimal seals
- New minimal easy fix wall profile system
- Choice of colour finishes available
- Integrated 'tray or floor' Water Safe System
- Designed for installation to straight vertical walls
- Compatible trays available
- Matt Black sandblast finish renders product essentially scratch-proof

Technical Information

Glass Thickness: 8mm, 10mm

Total Height: 2000mm

Handing: Reversible



Colour options for hardware

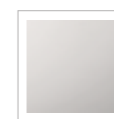

Polished Chrome
add **S** to Codes

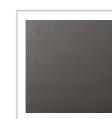

Matt Black
add **B** to Codes

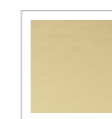

Brushed Brass
add **BR** to Codes

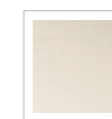

Brushed Nickel
add **N** to Codes

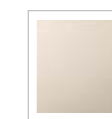

Polished Nickel
add **PN** to Codes



Corner Fitting

Description	Size (mm)	Glass Thickness	Adjustment (mm)	Code
Hinged Door for Corner	760	8mm	—	KL7613C
Hinged Door for Corner	800	8mm	—	KL813C
Hinged Door for Corner	900	8mm	—	KL913C
Hinged Door for Corner	1000	8mm	—	KL1013C
Side Panel	760	8mm	733 - 747	KR7613
Side Panel	800	8mm	773 - 787	KR813
Side Panel	900	8mm	873 - 887	KR913
Side Panel	1000	8mm	973 - 987	KR1013

Description	Size (mm)	Glass Thickness	Adjustment (mm)	Code
Hinged Door for Corner	760	10mm	—	TL7613C
Hinged Door for Corner	800	10mm	—	TL813C
Hinged Door for Corner	900	10mm	—	TL913C
Hinged Door for Corner	1000	10mm	—	TL1013C
Side Panel	760	10mm	733 - 747	TR7613
Side Panel	800	10mm	773 - 787	TR813
Side Panel	900	10mm	873 - 887	TR913
Side Panel	1000	10mm	973 - 987	TR1013

Alcove Fitting

Description	Size (mm)	Glass Thickness	Adjustment (mm)	Code
Hinged Door for Alcove	760	8mm	735 - 745	KL7613
Hinged Door for Alcove	800	8mm	775 - 785	KL813
Hinged Door for Alcove	900	8mm	875 - 885	KL913
Hinged Door for Alcove	1000	8mm	975 - 985	KL1013

Description	Size (mm)	Glass Thickness	Adjustment (mm)	Code
Hinged Door for Alcove	760	10mm	735 - 745	TL7613
Hinged Door for Alcove	800	10mm	775 - 785	TL813
Hinged Door for Alcove	900	10mm	875 - 885	TL913
Hinged Door for Alcove	1000	10mm	975 - 985	TL1013

Please note:

Liberty corner products are designed to be installed onto Roman standard trays and wet room floors. In the case of a tray installation; the tiles must not encroach the tray apron by more than 10mm. The adjustment range stated is the min-max product size.

Lead time of 3-4 weeks.

Hinged Door

with One In-line Panel

Features & Benefits

- Hinged from wall
- New clear and minimal seals
- New minimal easy fix wall profile system
- Integrated 'tray or floor' Water Safe System
- Designed for installation to straight vertical walls
- Optional brace bar included
- Matt Black sandblast finish renders product essentially scratch-proof

Technical Information

Glass Thickness: 8mm, 10mm

Total Height: 2000mm

Handing: Reversible



Colour options for hardware

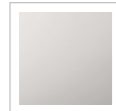

Polished Chrome
add **S** to Codes



Matt Black
add **B** to Codes

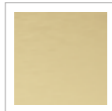

Brushed Brass
add **BR** to Codes



Brushed Nickel
add **N** to Codes

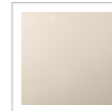

Polished Nickel
add **PN** to Codes



1000 Alcove Fitting - Brushed Nickel
8mm Door and In-Line Panel: KL1HD13N and KL1H1013N
Anti-Slip Tray: RSTG109 Shower Basket: RSB02



Corner Fitting

Size (mm)	Glass Thickness	Adjustment Side Panel (mm)	Door Code	In-line Panel Code	Side Panel Code
1000x800	8mm	763 - 777	KL1HDR13	KL1HR1013	KHR813
1000x900	8mm	863 - 877	KL1HDR13	KL1HR1013	KHR913
1200x800	8mm	763 - 777	KL1HDR13	KL1HR1213	KHR813
1200x900	8mm	863 - 877	KL1HDR13	KL1HR1213	KHR913
1400x800	8mm	763 - 777	KL1HDR13	KL1HR1413	KHR813
1400x900	8mm	863 - 877	KL1HDR13	KL1HR1413	KHR913
1600x800	8mm	763 - 777	KL1HDR13	KL1HR1613	KHR813

Size (mm)	Glass Thickness	Adjustment Side Panel (mm)	Door Code	In-line Panel Code	Side Panel Code
1000x800	10mm	763 - 777	TL1HDR13	TL1HR1013	THR813
1000x900	10mm	863 - 877	TL1HDR13	TL1HR1013	THR913
1200x800	10mm	763 - 777	TL1HDR13	TL1HR1213	THR813
1200x900	10mm	863 - 877	TL1HDR13	TL1HR1213	THR913
1400x800	10mm	763 - 777	TL1HDR13	TL1HR1413	THR813
1400x900	10mm	863 - 877	TL1HDR13	TL1HR1413	THR913
1600x800	10mm	763 - 777	TL1HDR13	TL1HR1613	THR813

Alcove Fitting

Size (mm)	Glass Thickness	Adjustment (mm)	Door Code	In-line Panel Code
760	8mm	733 - 747	KL1HD213	KL1H7613
800	8mm	773 - 787	KL1HD213	KL1H813
900	8mm	873 - 887	KL1HD13	KL1H913
1000	8mm	973 - 987	KL1HD13	KL1H1013
1200	8mm	1173 - 1187	KL1HD13	KL1H1213
1400	8mm	1373 - 1387	KL1HD13	KL1H1413
1600	8mm	1573 - 1587	KL1HD13	KL1H1613

Size (mm)	Glass Thickness	Adjustment (mm)	Door Code	In-line Panel Code
760	10mm	733 - 747	TL1HD213	TL1H7613
800	10mm	773 - 787	TL1HD213	TL1H813
900	10mm	873 - 887	TL1HD13	TL1H913
1000	10mm	973 - 987	TL1HD13	TL1H1013
1200	10mm	1173 - 1187	TL1HD13	TL1H1213
1400	10mm	1373 - 1387	TL1HD13	TL1H1413
1600	10mm	1573 - 1587	TL1HD13	TL1H1613

Please note:

Liberty corner products are designed to be installed onto Roman standard trays and wet room floors. In the case of a tray installation; the tiles must not encroach the tray apron by more than 15mm. The adjustment range stated is the min-max product size.

Hinged Door

with In-line Panel and Fluted Glass

Features & Benefits

- Hinged from wall
- New clear and minimal seals
- New minimal easy fix wall profile system
- Integrated 'tray or floor' Water Safe System
- Designed for installation to straight vertical walls
- Optional brace bar included
- Compatible trays available
- Matt Black sandblast finish renders product essentially scratch-proof

Technical Information

Glass Thickness: 8mm

Total Height: 2000mm

Handing: Left or Right handing must be specified when ordering

Corner Fitting

Size (mm)	Adjustment (mm)	Door Code*	In-line Panel Code*	Side Panel Code*
1200 x 800	763 - 777	KL1HDRF	KL1HR12F	KHR8F
1200 x 900	863 - 877	KL1HDRF	KL1HR12F	KHR9F
1400 x 800	763 - 777	KL1HDRF	KL1HR14F	KHR8F
1400 x 900	863 - 877	KL1HDRF	KL1HR14F	KHR9F
1600 x 800	763 - 777	KL1HDRF	KL1HR16F	KHR8F
1600 x 900	863 - 877	KL1HDRF	KL1HR16F	KHR9F

Alcove Fitting

Size (mm)	Adjustment (mm)	Door Code*	In-line Panel Code*
1200	1173 - 1187	KL1HDF	KL1H12F
1400	1373 - 1387	KL1HDF	KL1H14F
1600	1573 - 1587	KL1HDF	KL1H16F

Please note:

*Handing must be specified for the correct codes to be ordered, add L or R after Door, In-line and Side Panel code, Left as L, Right as R. Then add your preferred colour letter to codes.

Liberty corner products are designed to be installed onto Roman standard trays and wet room floors. In the case of a tray installation; the tiles must not encroach the tray apron by more than **15mm**. The adjustment range stated is the min-max product size.

Colour options for hardware



Polished Chrome
add **S** to Codes

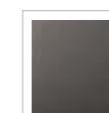

Matt Black
add **B** to Codes

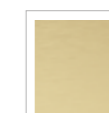

Brushed Brass
add **BR** to Codes

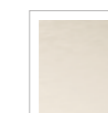

Brushed Nickel
add **N** to Codes

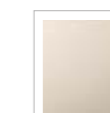

Polished Nickel
add **PN** to Codes

Black Grid Hinged Door

With In-line Panel

Features & Benefits

- Glass filled paint fired into the glass during toughening
- New minimal easy fix wall profile system
- Door is hinged from wall
- Integrated 'tray or floor' Water Safe System
- Designed for installation to straight vertical walls
- Optional brace bar included
- Compatible trays available
- Matt Black sandblast finish renders product essential-ity scratch-proof

Technical Information

Glass Thickness: 10mm

Total Height: 2000mm

Handing: Left or Right handing must be specified when ordering

Corner Fitting

Size (mm)	Adjustment (mm)	Door Code*	In-line Panel Code*	Side Panel Code*
1000x800	773 - 787	TL1HDRBGB	TL1HR10BGB	THR8BGB
1000x900	873 - 887	TL1HDRBGB	TL1HR10BGB	THR9BGB
1200x800	773 - 787	TL1HDRBGB	TL1HR12BGB	THR8BGB
1200x900	873 - 887	TL1HDRBGB	TL1HR12BGB	THR9BGB
1400x800	773 - 787	TL1HDRBGB	TL1HR14BGB	THR8BGB
1400x900	873 - 887	TL1HDRBGB	TL1HR14BGB	THR9BGB
1600x800	773 - 787	TL1HDRBGB	TL1HR16BGB	THR8BGB
1600x900	873 - 887	TL1HDRBGB	TL1HR16BGB	THR9BGB

Alcove Fitting

Size (mm)	Adjustment (mm)	Door Code*	In-line Panel Code*
760	733 - 747	TL1HD2BGB	TL1H76BGB
800	773 - 787	TL1HD2BGB	TL1H8BGB
900	873 - 887	TL1HDBGB	TL1H9BGB
1200	1173 - 1187	TL1HDBGB	TL1H12BGB

Please note:

*Handing must be specified for the correct codes to be ordered, add L or R after Door, In-line and Side Panel code, Left as L, Right as R.

Liberty corner products are designed to be installed onto Roman standard trays and wet room floors. In the case of a tray installation; the tiles must not encroach the tray apron by more than 10mm. The adjustment range stated is the min-max product size.

Colour options for hardware



Matt Black

Please note: All colours are available on request.



1200 Alcove Fitting (Left Hand)
1200 Door and In-Line Panel: TL1HDBGBL & TL1H12BGBL
Anti-Slip Tray: RSTG128 Shower Basket: RSB07B
Arched Black Grid Mirror: MIR02



Hinged Door with Hinged In-line Panel

Features & Benefits

- Hinged from In-Line Panel
- New clear and minimal seals
- New minimal easy fix wall profile system
- Integrated 'tray or floor' Water Safe System
- Designed for installation to straight vertical walls
- Optional brace bar included
- Matt Black sandblast finish renders product essentially scratch-proof

Technical Information

Glass Thickness: 8mm, 10mm

Total Height: 2000mm

Handing: Reversible

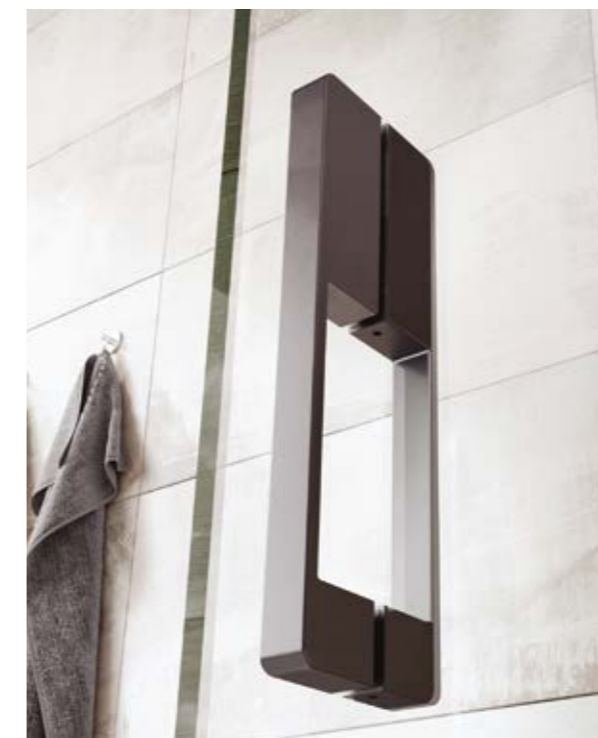

Colour options for hardware



Polished Chrome
add **S** to Codes

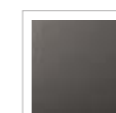

Matt Black
add **B** to Codes

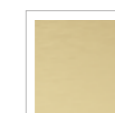

Brushed Brass
add **BR** to Codes

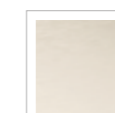

Brushed Nickel
add **N** to Codes

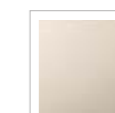

Polished Nickel
add **PN** to Codes



Corner Fitting outward opening only

Size (mm)	Glass Thickness	Adjustment Door and In-Line Panel (mm)	Adjustment Side Panel (mm)	Door Code	In-line Panel Code	Side Panel Code
1000x760	8mm	973-987	733-747	KL2HDR13	KL2HR1013	K1R7613
1000x800	8mm	973-987	773-787	KL2HDR13	KL2HR1013	K1R813
1000x900	8mm	973-987	873-887	KL2HDR13	KL2HR1013	K1R913
1000x1000	8mm	973-987	973-987	KL2HDR13	KL2HR1013	K1R1013
1200x760	8mm	1173-1187	733-747	KL2HDR13	KL2HR1213	K1R7613
1200x800	8mm	1173-1187	773-787	KL2HDR13	KL2HR1213	K1R813
1200x900	8mm	1173-1187	873-887	KL2HDR13	KL2HR1213	K1R913
1200x1000	8mm	1173-1187	973-987	KL2HDR13	KL2HR1213	K1R1013

Size (mm)	Glass Thickness	Adjustment Door and In-Line Panel (mm)	Adjustment Side Panel (mm)	Door Code	In-line Panel Code	Side Panel Code
1000x760	10mm	973-987	733-747	TL2HDR13	TL2HR1013	T1R7613
1000x800	10mm	973-987	773-787	TL2HDR13	TL2HR1013	T1R813
1000x900	10mm	973-987	873-887	TL2HDR13	TL2HR1013	T1R913
1000x1000	10mm	973-987	973-987	TL2HDR13	TL2HR1013	T1R1013
1200x760	10mm	1173-1187	733-747	TL2HDR13	TL2HR1213	T1R7613
1200x800	10mm	1173-1187	773-787	TL2HDR13	TL2HR1213	T1R813
1200x900	10mm	1173-1187	873-887	TL2HDR13	TL2HR1213	T1R913
1200x1000	10mm	1173-1187	973-987	TL2HDR13	TL2HR1213	T1R1013

Alcove Fitting inward or outward opening

Size (mm)	Glass Thickness	Adjustment (mm)	Door Code	In-line Panel Code
1000	8mm	973-987	KL2HD13	KL2H1013
1200	8mm	1173-1187	KL2HD13	KL2H1213

Size (mm)	Glass Thickness	Adjustment (mm)	Door Code	In-line Panel Code
1000	10mm	973-987	TL2HD13	TL2H1013
1200	10mm	1173-1187	TL2HD13	TL2H1213

Please note:

Liberty corner products are designed to be installed onto Roman standard trays and wet room floors. In the case of a tray installation; the tiles must not encroach the tray apron by more than 10mm. The adjustment range stated is the min-max product size.

Hinged Door with Two In-line Panels

Features & Benefits

- Hinged from In-Line Panel
- New clear and minimal seals
- New minimal easy fix wall profile system
- Integrated 'tray or floor' Water Safe System
- Designed for installation to straight vertical walls
- Optional brace bars included
- Compatible trays available
- Matt Black sandblast finish renders product essential-ity scratch-proof

Technical Information

Glass Thickness: 8mm, 10mm

Total Height: 2000mm

Handing: Reversible



1600 Alcove Fitting - Matt Black
8mm Door and In-Line Panel: KLHD13B and KLH1613B
Infinity Slate Tray: IGS168W Shower Basket: RSB05B

Colour options for hardware



Polished Chrome
add S to Codes

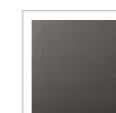

Matt Black
add B to Codes

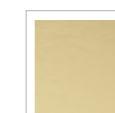

Brushed Brass
add BR to Codes

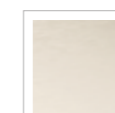

Brushed Nickel
add N to Codes

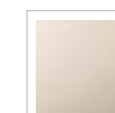

Polished Nickel
add PN to Codes

1600 Alcove Fitting - Brushed Brass

8mm Door and In-Line Panel: KLHD13BR and KLH1613BR
Infinity Slate Tray: IGS168W Shower Basket: RSB05BR



Corner Fitting

Size (mm)	Glass Thickness	Adjustment Door and In-Line Panel (mm)	Adjustment Side Panel (mm)	Door Code	In-line Panel Code	Side Panel Code
1200x800	8mm	1163 - 1177	763 - 777	KLHDR13	KLHR1213	KHR813
1200x900	8mm	1163 - 1177	863 - 877	KLHDR13	KLHR1213	KHR913
1400x800	8mm	1363 - 1377	763 - 777	KLHDR13	KLHR1413	KHR813
1400x900	8mm	1363 - 1377	863 - 877	KLHDR13	KLHR1413	KHR913
1600x800	8mm	1563 - 1577	763 - 777	KLHDR13	KLHR1613	KHR813
1600x900	8mm	1563 - 1577	863 - 877	KLHDR13	KLHR1613	KHR913

Size (mm)	Glass Thickness	Adjustment Door and In-Line Panel (mm)	Adjustment Side Panel (mm)	Door Code	In-line Panel Code	Side Panel Code
1200x800	10mm	1163 - 1177	763 - 777	TLHDR13	TLHR1213	THR813
1200x900	10mm	1163 - 1177	863 - 877	TLHDR13	TLHR1213	THR913
1400x800	10mm	1363 - 1377	763 - 777	TLHDR13	TLHR1413	THR813
1400x900	10mm	1363 - 1377	863 - 877	TLHDR13	TLHR1413	THR913
1600x800	10mm	1563 - 1577	763 - 777	TLHDR13	TLHR1613	THR813
1600x900	10mm	1563 - 1577	863 - 877	TLHDR13	TLHR1613	THR913

Alcove Fitting

Size (mm)	Glass Thickness	Adjustment (mm)	Door Code	In-line Panel Code
1200	8mm	1166 - 1194	KLHD13	KLH1213
1400	8mm	1366 - 1394	KLHD13	KLH1413
1600	8mm	1566 - 1594	KLHD13	KLH1613

Size (mm)	Glass Thickness	Adjustment (mm)	Door Code	In-line Panel Code
1200	10mm	1166 - 1194	TLHD13	TLH1213
1400	10mm	1366 - 1394	TLHD13	TLH1413
1600	10mm	1566 - 1594	TLHD13	TLH1613

Please note:

Liberty corner products are designed to be installed onto Roman standard trays and wet room floors. In the case of a tray installation; the tiles must not encroach the tray apron by more than 15mm. The adjustment range stated is the min-max product size.



Neo Angle Enclosure

Features & Benefits

- Chromed brass machined components
- Chromed brass self-closing hinges and feature handle
- Low profile PVC seals
- Integrated 'tray or floor' Water Safe System
- Please indicate handing (RH or LH) when ordering
- Door always hinges from the short panel
- Compatible trays available. For more tray information please see page 139

Technical Information

Glass Thickness: 10mm

Total Height: 2008mm

Handing: Left or Right handing must be specified when ordering

Shower Enclosures

Size (mm)	Handing	Adjustment (mm)	Door Code	Neo-Panels Code
900 x 900	Left Hand	860 - 875	DXPDB	DXP9PAL
900 x 900	Right Hand	860 - 875	DXPDB	DXP9PAR
1200 x 900	Left Hand	1160 - 1175 & 860 - 875	DXPDB	DXP129PAL
1200 x 900	Right Hand	1160 - 1175 & 860 - 875	DXPDB	DXP129PAR

Please note: Door aperture/projection is 660mm - enclosure size required is achieved by size of Neo Panels (this is reflected in Order Codes).

Shower Trays

Width (mm)	Depth (mm)	Height (mm)	Handing	Code
900	900	40	—	RNG90
1200	900	40	Left Hand	RNG129L
1200	900	40	Right Hand	RNG129R



Right Hand 1200 x 900mm



Left Hand 1200 x 900mm



900 x 900mm

Colour options for hardware

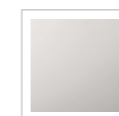

Polished Chrome

Colour for Trays Finish

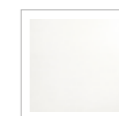

White



Innov8

Frameless Collection

The Innov8 Range encapsulates industrial chic with an elegant twist.

Innov8 Enclosures lead the way in minimal, inclusive and stylish design trends - presenting a refined collection.

Innov8's outstanding differential is the low threshold (reduced height of bottom rail), allowing level entry access into the Shower Enclosure.



FastFix

S Y S T E M



SECONDS



PRE-ASSEMBLED

3

THREE STEP

FastFix Assembly

now included on all Roman Sliding Door Enclosures

The FastFix Assembly system is designed so that the final mainframe installation is a 'slot and tighten' exercise, which can be done literally in seconds. Consequently, the main profiles effortlessly link together as the structure is assembled onsite. As much of the process as possible is now pre-assembled in the Roman factory to ensure that the final installation in the bathroom is simple, quick and easy.

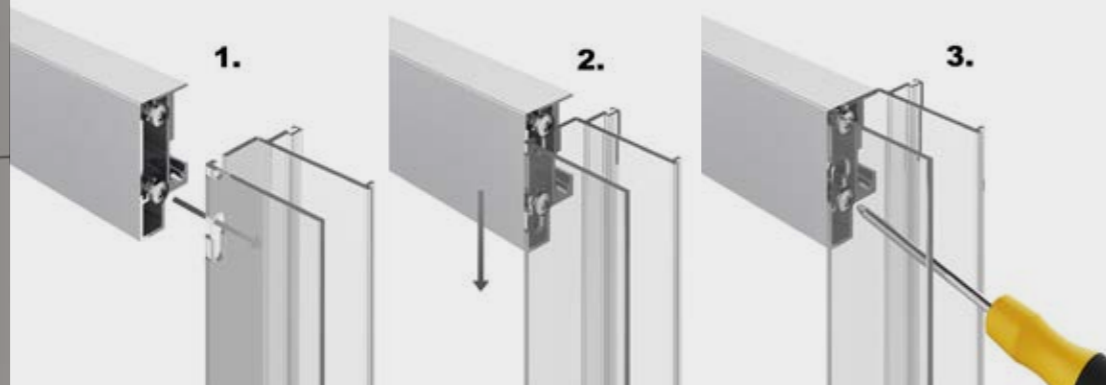

Sliding Door

Features & Benefits

- Chromed brass machined components
- Chromed brass feature handle
- Crystal clear PVC seals
- 20mm of adjustment in each profile
- Fast Fix Assembly
- Compatible trays available
- Matt Black sandblast finish renders product essentially scratch-proof

Technical Information

Glass Thickness: 8mm

Total Height: 1950mm

Handing: Reversible

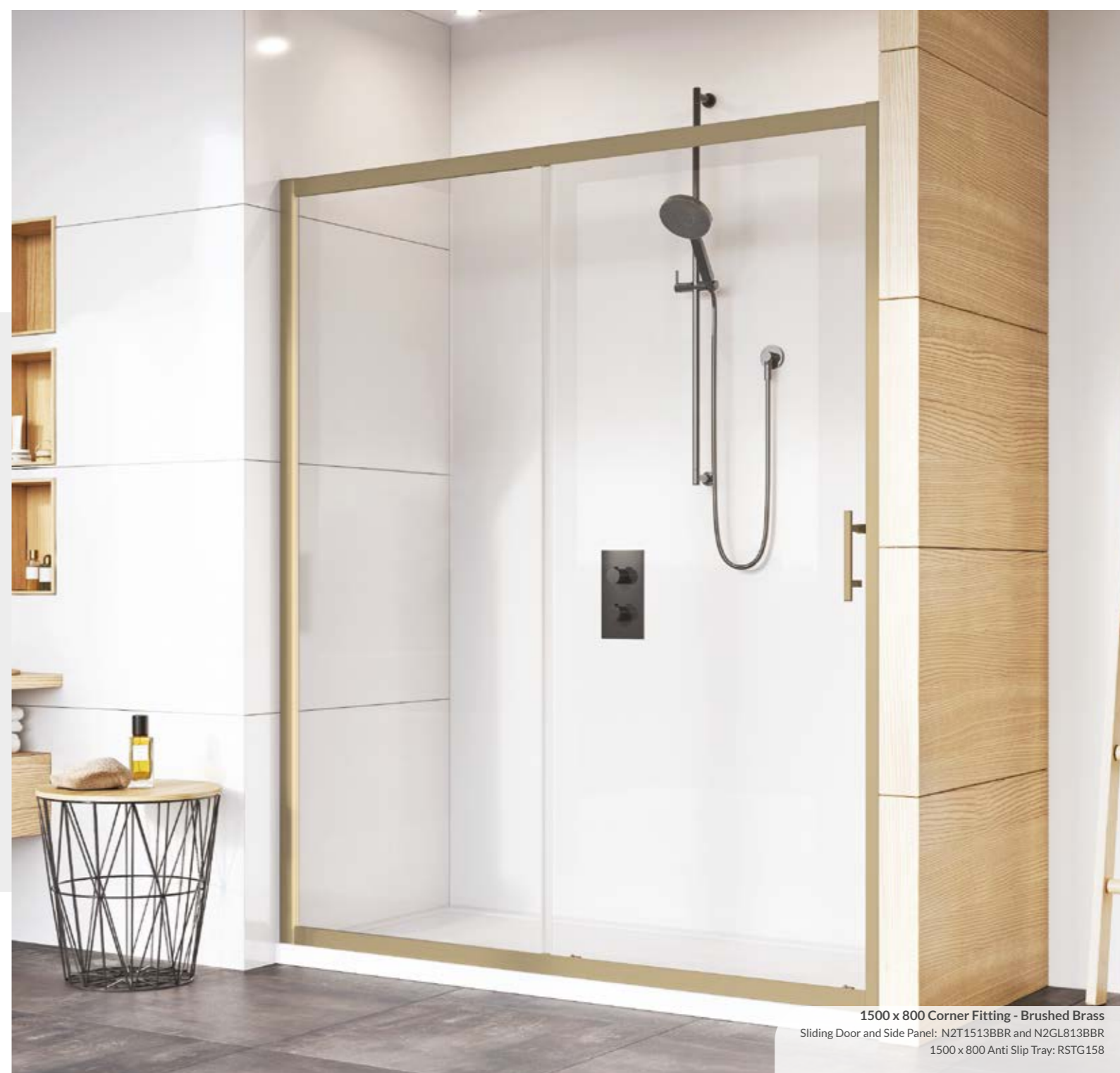

1500 x 800 Corner Fitting - Brushed Brass
Sliding Door and Side Panel: N2T1513BBR and N2GL813BBR
1500 x 800 Anti Slip Tray: RSTG158



1500 x 800 Corner Fitting - Polished Chrome
 Sliding Door and Side Panel: N2T1513S and N2GL813S
 1500 x 800 Anti Slip Tray: RSTG158 Shower Basket: RSB03

Corner Fitting

Size (mm)	Adjustment Door (mm)	Adjustment Side Panel (mm)	Door Code	Side Panel Code
1200x800	1170 - 1190	755 - 775	N2T1213	N2GL813
1200x900	1170 - 1190	855 - 875	N2T1213	N2GL913
1400x800	1370 - 1390	755 - 775	N2T1413	N2GL813
1400x900	1370 - 1390	855 - 875	N2T1413	N2GL913
1500x800	1470 - 1490	755 - 775	N2T1513	N2GL813
1500x900	1470 - 1490	855 - 875	N2T1513	N2GL913
1700x800	1670 - 1690	755 - 775	N2T1713	N2GL813
1700x900	1670 - 1690	855 - 875	N2T1713	N2GL913

Alcove Fitting

Size (mm)	Adjustment (mm)	Door Code
1200	1150 - 1190	N2T1213
1400	1350 - 1390	N2T1413
1500	1450 - 1490	N2T1513
1700	1650 - 1690	N2T1713

Extension Profile

Description	Height (mm)	Adds Extra (mm)	Code
Extension Profile	1950	35	VZEX2*

*Please note: Only used for Polished Chrome and Matt Black.

Colour options for hardware

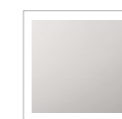

Polished Chrome
add S to Codes



Matt Black
add B to Codes



Brushed Brass
add BBR to Codes



900 x 1200 Quadrant - Brushed Brass
 Quadrant Door: N2SQ1213BBR
 Anti-Slip Quadrant Tray: RSQG129R
 Shower Basket: RSB02BR



900 x 900 Quadrant - Polished Chrome
 Quadrant Door: N2SQ913S
 Anti-Slip Quadrant Tray: RSQG90
 Shower Basket: RSB07

Curved Quadrant

Features & Benefits

- Chromed brass machined components
- Chromed brass feature handle
- Crystal clear PVC seals
- 20mm of adjustment in each profile
- Fast Fix Assembly
- Compatible trays available
- Matt Black sandblast finish renders product essentially scratch-proof

Technical Information

Glass Thickness: 8mm
Total Height: 1950mm
Handing: Reversible

Size (mm)	Adjustment (mm)	Code
900 x 900	855 - 875	N2SQ913
800 x 900	755 - 775 & 855 - 875	N2SQ8913
800 x 1000	755 - 775 & 955 - 975	N2SQ81013
800 x 1200	755 - 775 & 1155 - 1175	N2SQ81213
900 x 1200	855 - 875 & 1155 - 1175	N2SQ91213

Colour options for hardware

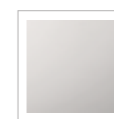

Polished Chrome
 add **S** to Codes



Matt Black
 add **B** to Codes

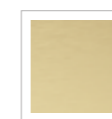

Brushed Brass
 add **BBR** to Codes



11NOV8 HINGED

1200 Alcove Fitting - Brushed Brass
 Hinged Door and In-Line Panel:
 NL2HD13BBR and NL2H1213BBR
 Infinity Slate Tray: IGS128W, Shower Basket: RSB04

Hinged Door *with In-line Panel*

Corner Fitting

Size (mm)	Adjustment (mm) Door and In-Line Panel	Adjustment (mm) Side Panel	Door Code	In-line Panel Code	Side Panel Code
1000x800	955 - 975	755 - 775	NL2HDR13	NL2HR1013	N2R813
1000x900	955 - 975	855 - 875	NL2HDR13	NL2HR1013	N2R913
1200x800	1155 - 1175	755 - 775	NL2HDR13	NL2HR1213	N2R813
1200x900	1155 - 1175	855 - 875	NL2HDR13	NL2HR1213	N2R913

Alcove Fitting

Size (mm)	Adjustment (mm)	Door Code	In-line Panel Code
1000	950 - 990	NL2HD13	NL2H1013
1200	1150 - 1190	NL2HD13	NL2H1213

Colour options for hardware

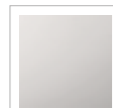

Polished Chrome
add **S** to Codes



Matt Black
add **B** to Codes

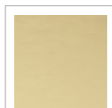

Brushed Brass
add **BBR** to Codes

Features & Benefits

- Chromed brass machined components
- Chromed brass feature handle
- Crystal clear PVC seals
- 20mm of adjustment in each profile
- No top rail
- Side Panels supplied with optional bracing
- Compatible trays available
- Matt Black sandblast finish renders product essentiality scratch-proof

Technical Information

Glass Thickness: 8mm

Total Height: 1950mm

Handing: Reversible



1000 x 800 Corner Fitting - Matt Black
 Hinged Door: NL2HDR13B, In-Line Panel: NL2HR1013B, Side Panel: N2R813B
 Infinity Slate Tray: IGS108B
 Shower Basket: RSB02B



1200 Alcove Fitting - Matt Black
 Hinged Door: NLHD13B, In-Line Panel: NLH1213B
 Anti-Slip Tray: RSTG128, Shower Basket: RSB05B

Hinged Door with Two In-line Panels

Features & Benefits

- Chromed brass machined components
- Chromed brass feature handle
- Crystal clear PVC seals
- 20mm of adjustment in each profile
- No top rail
- Side Panels supplied with optional bracing
- Compatible trays available
- Matt Black sandblast finish renders product essentially scratch-proof

Corner Fitting

Size (mm)	Adjustment (mm) Door and In-Line Panel	Adjustment Side Panel (mm)	Door Code	In-line Panel Code	Side Panel Code
1200x800	1155 - 1175	755 - 775	NLHDR13	NLHR1213	N3R813
1200x900	1155 - 1175	855 - 875	NLHDR13	NLHR1213	N3R913
1400x800	1355 - 1375	755 - 775	NLHDR13	NLHR1413	N3R813
1400x900	1355 - 1375	855 - 875	NLHDR13	NLHR1413	N3R913
1600x800	1555 - 1575	755 - 775	NLHDR13	NLHR1613	N3R813
1600x900	1555 - 1575	855 - 875	NLHDR13	NLHR1613	N3R913

Alcove Fitting

Size (mm)	Adjustment (mm)	Door Code	In-line Panel Code
1200	1150 - 1190	NLHD13	NLH1213
1400	1350 - 1390	NLHD13	NLH1413
1600	1550 - 1590	NLHD13	NLH1613

Technical Information

Glass Thickness: 8mm

Total Height: 1950mm

Handing: Reversible



1600 x 800 Corner Fitting - Brushed Brass
 Hinged Door: NLHDR13BBR, In-Line Panel: NLHR1613BBR
 Side Panel: N3R813BBR, Anti-Slip Tray: RSTG168

Colour options for hardware

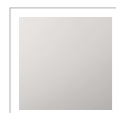

Polished Chrome
add **S** to Codes

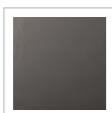

Matt Black
add **B** to Codes

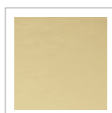

Brushed Brass
add **BBR** to Codes



900 x 900 Corner Fitting - Polished Chrome
 Pivot Door: N2F913CS, Side Panel: N2R913S
 Anti-Slip Tray: RSTG90, Shower Basket: RSB07

Pivot Door

Features & Benefits

- Chromed brass machined components
- Chromed brass feature handle
- No top rail
- Full length pivoting tube
- Side Panels supplied with optional bracing
- Compatible trays available
- Crystal clear PVC seals
- Matt Black sandblast finish renders product essentially scratch-proof

Technical Information

Glass Thickness: 8mm
Total Height: 1967mm
Handing: Reversible

Colour options for hardware

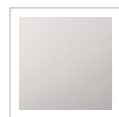

Polished Chrome
 add **S** to Codes



Matt Black
 add **B** to Codes



900 Alcove Fitting - Matt Black
 Pivot Door: N2F913B Anti-Slip Tray: RSGT90
 Shower Basket: RSB02, Black Grid Mirror MIR02



Corner Fitting

Description	Size (mm)	Adjustment (mm)	Code
Door	760	715 - 735	N2F7613C
Door	800	755 - 775	N2F813C
Door	900	855 - 875	N2F913C
Side Panel	760	715 - 735	N2R7613
Side Panel	800	755 - 775	N2R813
Side Panel	900	855 - 875	N2R913

Alcove Fitting

Size (mm)	Adjustment (mm)	Code
760	710 - 750	N2F7613
800	750 - 790	N2F813
900	850 - 890	N2F913



1200 x 900 Corner Fitting - Matt Black
 1200 Door, In-Line Panel and Side Panel:
 N2F1HDR13B, N2HR1213B and N2HR913B
 Anti-Slip Tray: RSTG129, Shower Basket: RSB02
 Arched Black Grid Mirror: MIR02

Pivot Door with In-line Panel

Features & Benefits

- Chromed brass machined components
- Chromed brass feature handle
- 20mm of adjustment in each profile
- No top rail
- Full length pivoting tube
- In-Line Panels supplied with optional bracing
- Rubber handle stopper included for Inward or Outward opening doors
- Compatible trays available
- Crystal clear PVC seals
- Matt Black sandblast finish renders product essentiality scratch-proof

Technical Information

Glass Thickness: 8mm

Total Height: 1967mm

Handing: Reversible

Corner Fitting

Size (mm)	Adjustment (mm) Door and In-Line Panel	Adjustment (mm) Side Panel	Door Code	In-line Panel Code	Side Panel Code
1000 x 800	955 - 975	755 - 775	N2F1HDR13	N2HR1013	N2HR813
1000 x 900	955 - 975	855 - 875	N2F1HDR13	N2HR1013	N2HR913
1200 x 800	1155 - 1175	755 - 775	N2F1HDR13	N2HR1213	N2HR813
1200 x 900	1155 - 1175	855 - 875	N2F1HDR13	N2HR1213	N2HR913
1400 x 800	1355 - 1375	755 - 775	N2F2HDR13	N2HR1413	N2HR813
1400 x 900	1355 - 1375	855 - 875	N2F2HDR13	N2HR1413	N2HR913
1500 x 800	1455 - 1475	755 - 775	N2F2HDR13	N2HR1513	N2HR813
1500 x 900	1455 - 1475	855 - 875	N2F2HDR13	N2HR1513	N2HR913

Alcove Fitting

Size (mm)	Adjustment (mm)	Door Code	In-line Panel Code
1000	950 - 990	N2F1HD13	N2H1013
1200	1150 - 1190	N2F1HD13	N2H1213
1400	1350 - 1390	N2F2HD13	N2H1413
1500	1450 - 1490	N2F2HD13	N2H1513

Colour options for hardware



Polished Chrome
add **S** to Codes

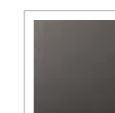

Matt Black
add **B** to Codes



Rubber handle stopper



900 x 900 Corner Fitting - Polished Chrome
Bi-Fold Door: N2V913CS, Side Panel: N2R913S
Anti-Slip Tray: RSTG90

1200 x 800 Corner Fitting - Polished Chrome
Bi-Fold Door: N3V1213S, Side Panel: N2GL813S
Anti-Slip Tray: RSTG128, Shower Basket:RSB07

Bi-Fold Door *Framed*

Features & Benefits

- Chromed brass hinges
- Chromed top caps
- Compatible trays available
- Crystal clear PVC seals
- Minimum top and bottom rails
- Smooth inward opening
- Matt Black sandblast finish renders product essentially scratch-proof

Technical Information

Glass Thickness: 6mm
Total Height: 1950mm
Handing: Reversible

Colour options for hardware

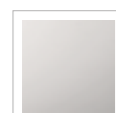

Polished Chrome
add **S** to Codes

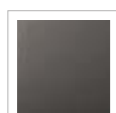

Matt Black
add **B** to Codes

Fully Assembled
Easy to Install

Corner Fitting

Description	Size (mm)	Adjustment for Corner (mm)	Adjustment for Alcove (mm)	Code
Bi-Fold Door	760	730-750	710-750	N3V7613
Bi-Fold Door	800	770-790	750-790	N3V813
Bi-Fold Door	900	870-890	850-890	N3V913
Bi-Fold Door	1000	970-990	950-990	N3V1013
Bi-Fold Door	1200	1170-1190	1150-1190	N3V1213
Side Panel	800	755-775	755-775	N2GL813
Side Panel	900	855-875	855-875	N2GL913

Alcove Fitting

Description	Size (mm)	Adjustment for Corner (mm)	Adjustment for Alcove (mm)	Code
Bi-Fold Door	760	710-750	710-750	N3V7613
Bi-Fold Door	800	750-790	750-790	N3V813
Bi-Fold Door	900	850-890	850-890	N3V913
Bi-Fold Door	1000	950-990	950-990	N3V1013
Bi-Fold Door	1200	1150-1190	1150-1190	N3V1213

Bi-Fold Door *Frameless*

Features & Benefits

- Inward opening doors with 180° pivoting action
- Chromed brass hinges
- Chromed top caps
- No top rail
- Elimination of the bottom rail creating level access entry
- Compatible trays available
- Crystal clear PVC seals
- Matt Black sandblast finish renders product essentially scratch-proof

Technical Information

Glass Thickness: 8mm

Total Height: 1967mm

Handing: Reversible

Colour options for hardware

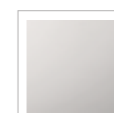

Polished Chrome
add **S** to Codes

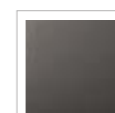

Matt Black
add **B** to Codes

Corner Fitting

Description	Size (mm)	Adjustment (mm)	Code
Bi-Fold Door	760	715 - 735	N2V7613C
Bi-Fold Door	800	755 - 775	N2V813C
Bi-Fold Door	900	855 - 875	N2V913C
Bi-Fold Door	1000	955 - 975	N2V1013C
Side Panel*	760	715 - 735	N2R7613
Side Panel*	800	755 - 775	N2R813
Side Panel*	900	855 - 875	N2R913
Side Panel*	1000	955 - 975	N2R1013

* Side Panel supplied with optional brace bar

Alcove Fitting

Description	Size (mm)	Adjustment (mm)	Code
Bi-Fold Door	760	710 - 750	N2V7613
Bi-Fold Door	800	750 - 790	N2V813
Bi-Fold Door	900	850 - 890	N2V913
Bi-Fold Door	1000	950 - 990	N2V1013



Walk-in Shower Enclosure

Bath replacement

Features & Benefits

- Bath replacement Enclosure
- Occupies the same wall dimensions as a standard UK bath (1700 x 700cm)
- Its curvaceous nature bows out to create a spacious and indulgent showering space
- Effortless showering with doors eliminated and sweeping level access
- It imitates a wetroom in its styling, whilst providing a more enclosed showering area
- It has a dedicated shower tray, which is approved for anti-slip properties

Technical Information

Glass Thickness: 8mm

Total Height: 1950mm

Handing: Reversible

Description	Fixed Panel (mm)	Adjustment (mm)	Code
Curved Panel	1202	25	V8C13S
Curved Panel + 1 Side Panel	1202	25	V8CG13S
Curved Panel + Return Panel	1202	25	V8CGM13S
Curved Panel + 2 Side Panels	1202	25	V8CGR13S

Walk-in Shower Tray

Features & Benefits

- Ultra low profile
- 50mm nominal height
- Solid surface with gel coat finish
- Includes chrome grid waste and fast flow trap
- Suitable for use with power shower systems rated up to 25 litres per minute

Width (mm)	Depth (mm)	Height (mm)	Handing	Code
1700	700	50	Left Hand	RCC177L
1700	700	50	Right Hand	RCC177R

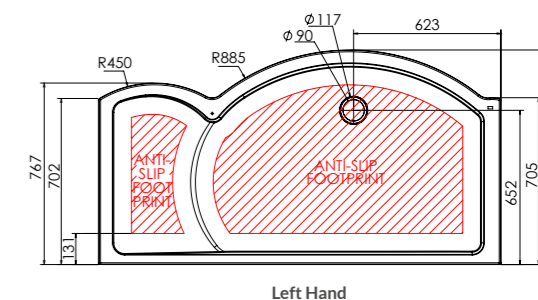

Colour options for hardware



Polished Chrome

Tray Colour Finish



White

EasyClean

Anti-Slip
DIN Class C

1700 Walk-in Shower Enclosure - Polished Chrome
Curved Panel: V8C13S
Innov8 Walk-in Dedicated Shower Tray: RCC177R
Shower Basket: RSB06

Embrace

Semi-Frameless Collection

Imaginative, urbane and innovative showering solutions designed to maximise space.

Our Embrace Collection brings together an innovative and stylish collection of shower enclosures offering high performance and design benefits at an extremely competitive price.



1200 Corner Fitting
Sliding Door: ET1213S, Side Panel: EGL913S
Anti-Slip Tray: RSTG129, Shower Basket: RSB03

Sliding Door

Features & Benefits

- PVC vertical seals
- Adjustable smooth running bearings
- 'Quick release' door mechanism
- Compatible trays available

Technical Information

Glass Thickness: 6mm
Total Height: 1900mm
Handing: Reversible

Corner Panel 6mm Glass Thickness

Size (mm)	Adjustment (mm)	Code
1000	950 - 1000	ET1013S
1100	1050 - 1100	ET1113S
1200	1150 - 1200	ET1213S
1400	1350 - 1400	ET1413S
1700	1650 - 1700	ET1713S

Side Panel 6mm Glass Thickness

Description	Size (mm)	Adjustment (mm)	Product Suitability Code	Code
Side Panel	700	660 - 685	EF/EV/ET	EGL713S
Side Panel	760	720 - 745	EF/EV/ET	EGL7613S
Side Panel	800	760 - 785	EF/EV/ET	EGL813S
Side Panel	900	860 - 885	EF/EV/ET	EGL913S
Side Panel	1000	960 - 985	EF/EV/ET	EGL1013S

Inline Panel & Neo Angle 8mm Glass Thickness

Description	Size (mm)	Adjustment (mm)	Product Suitability Code	Code
In-Line Panel	200	950 - 1000	EF76/EV76	EHL213S
In-Line Panel	300	1050 - 1100	EF76/EV76	EHL313S
In-Line Panel	400	1145 - 1195	EF/EV	EHL413S
In-Line Panel	800	1532 - 1582	EV9/EF9	EHL813S
Neo Panel Pack	900 x 900	17 each side	EV76/EF76	EP913S*
Neo Panel Pack	1200 x 900	17 each side	EV76/EF76	EP1213S*
Extension profile	1900	35 (extra)	EF/EV/ET	EZEXS

Please note:

*For use with Bi-fold and Pivot Doors
Please note that other configurations are available for In-Line Panels.
Contact Customer Services 01325 328033

Colour options for hardware

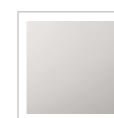

Polished Chrome

All Embrace series products use Polished Chrome Finish



900 Corner Fitting
Pivot Door: EF913S, Side Panel: EGL913S
Anti-Slip Tray: RSTG90, Shower Basket: RSB06

Pivot Door

Features & Benefits

- Magnetic door closing
- PVC vertical seals
- Reduced opening into room due to hinge position
- Outward opening doors must be hinged from the wall
- Compatible trays available

Technical Information

Glass Thickness: 6mm

Total Height: 1900mm

Handing: Reversible

FullyAssembled
Easy to Install

Pivot Door

Size (mm)	Adjustment (mm)	Code
760	715 - 760	EF7613S
800	755 - 800	EF13S
900	855 - 900	EF913S

Side Panel 6mm Glass Thickness

Description	Size (mm)	Adjustment (mm)	Product Suitability Code	Code
Side Panel	700	660 - 685	EF/EV/ET	EGL713S
Side Panel	760	720 - 745	EF/EV/ET	EGL7613S
Side Panel	800	760 - 785	EF/EV/ET	EGL813S
Side Panel	900	860 - 885	EF/EV/ET	EGL913S
Side Panel	1000	960 - 985	EF/EV/ET	EGL1013S

Inline Panel & Neo Angle 8mm Glass Thickness

Description	Size (mm)	Adjustment (mm)	Product Suitability Code	Code
In-Line Panel	200	950 - 1000	EF76/EV76	EHL213S
In-Line Panel	300	1050 - 1100	EF76/EV76	EHL313S
In-Line Panel	400	1145 - 1195	EF/EV	EHL413S
In-Line Panel	800	1532 - 1582	EV9/EF9	EHL813S
Neo Panel Pack	900 x 900	17 each side	EV76/EF76	EP913S*
Neo Panel Pack	1200 x 900	17 each side	EV76/EF76	EP1213S*
Extension profile	1900	35 (extra)	EF/EV/ET	EZEXS

Bi-Fold Door

Features & Benefits

- Smooth running roller bearings
- Compatible trays available

Technical Information

Glass Thickness: 6mm

Total Height: 1900mm

Handing: Reversible

Bi-Fold Door

Size (mm)	Adjustment (mm)	Code
760	715 - 760	EV7613S
800	755 - 800	EV13S
900	855 - 900	EV913S
1000	955 - 1000	EV1013S
1200	1155 - 1200	EV1213S

Side Panel 6mm Glass Thickness

Description	Size (mm)	Adjustment (mm)	Product Suitability Code	Code
Side Panel	700	660 - 685	EF/EV/ET	EGL713S
Side Panel	760	720 - 745	EF/EV/ET	EGL7613S
Side Panel	800	760 - 785	EF/EV/ET	EGL813S
Side Panel	900	860 - 885	EF/EV/ET	EGL913S
Side Panel	1000	960 - 985	EF/EV/ET	EGL1013S

Inline Panel & Neo Angle 8mm Glass Thickness

Description	Size (mm)	Adjustment (mm)	Product Suitability Code	Code
In-Line Panel	200	950 - 1000	EF76/EV76	EHL213S
In-Line Panel	300	1050 - 1100	EF76/EV76	EHL313S
In-Line Panel	400	1145 - 1195	EF/EV	EHL413S
In-Line Panel	800	1532 - 1582	EV9/EF9	EHL813S
Neo Panel Pack	900 x 900	17 each side	EV76/EF76	EP913S*
Neo Panel Pack	1200 x 900	17 each side	EV76/EF76	EP1213S*
Extension profile	1900	35 (extra)	EF/EV/ET	EZEXS



Neo Angle Pack
900 x 900mm
Neo Angle Pack: EP913S
Neo Angle Trays: RNG90
Shower Basket: RSB01

FullyAssembled
Easy to Install

1200 Alcove Fitting

Bi-Fold Door: EV1213S

Anti-Slip Tray: RSTG129, Shower Basket: RSB02



Haven

Collection

The Haven Collection is available from 10mm to 4mm thick toughened glass and encompasses an array of shower enclosures, a selection of side panels and in-line panels, stylish bath screens and stylish wetroom panels.

The Collection incorporates the ranges Haven8, Haven6, Haven Framed and Haven Select Wetroom Panels.



1200mm Sliding Door - H4S12CBR
Anti-Slip Tray: RSTG128, Shower Basket: RSB05BR



1200mm Level Access Sliding Door - H4LEL12CS (Left Hand)
Anti-Slip Tray: RSTG128, Shower Basket: RSB02

Sliding Door

Features & Benefits

- Chromed brass handle
- 'Minimal' low profile seals
- Smooth running 'quick release' roller bearings
- 25mm vertical adjustment in each profile
- Reversible for left or right hand fixing
- Matt Black sandblast finish renders product essentially scratch-proof

Technical Information

Glass Thickness: 8mm

Total Height: 1950mm

Handing: Reversible

Colour options for hardware

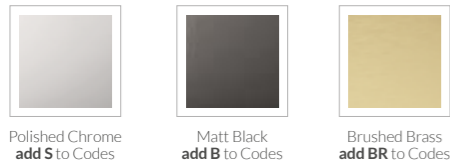

Please note:
Matt Black and Brushed Brass are available in Spring 2025

FastFix
SYSTEM

Haven8 Collection Shower Enclosure

Level Access Sliding Door

Features & Benefits

- Chromed brass handle
- Polished Chrome frame
- Optional bottom rail
- Easy release door function
- 25mm vertical adjustment in each profile
- Not reversible - left or right handing must be specific

Technical Information

Glass Thickness: 8mm

Total Height: 1950mm

Handing: Left or Right handing must be specified when ordering

Colour options for hardware

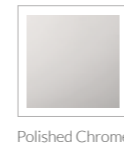

Polished Chrome

Size (mm)	Adjustment (mm) Alcove Fitting	Adjustment (mm) Side Panel	Code*
1000	940 - 990	957 - 1007	H4LEL10CS
1100	1040 - 1090	1057 - 1107	H4LEL11CS
1200	1140 - 1190	1157 - 1207	H4LEL12CS
1400	1340 - 1390	1357 - 1407	H4LEL14CS
1500	1440 - 1490	1457 - 1507	H4LEL15CS
1700	1640 - 1690	1657 - 1707	H4LEL17CS

*Please note: **Handing must be specified for the correct codes to be ordered.** The Code shows Left side, to order right side, please change the L to R. eg e.g H4LEL10CS to H4LER10CS

Description	Size (mm)	Adjustment (mm)	Code
Side Panel	700	640-690	H4R7CS
Side Panel	760	710 - 735	H4R76CS
Side Panel	800	750 - 775	H4R8CS
Side Panel	900	850 - 875	H4R9CS
Side Panel	1000	950 - 975	H4R10CS
Extension Profile	1950 High	35mm extra	H4ZEX2S
Mini-Extension Profile	1950 High	15mm extra	H4ZEX3S

FastFix
SYSTEM



Two Door Quadrant

Features & Benefits

- Chromed brass handles
- 'Minimal' low profile seals
- Smooth running 'quick release' roller bearings
- 25mm vertical adjustment in each profile
- Reversible for left or right hand fixing

Technical Information

Glass Thickness: 8mm

Total Height: 1950mm

Handing: Reversible

Colour options for hardware

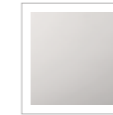

Polished Chrome

Description	Size (mm)	Adjustment (mm)	Code
Two Door Quadrant	800x800	750 - 775	H4Q8CS
Two Door Quadrant	900x900	850 - 875	H4Q9CS
Two Door Offset Quadrant	800x900	750 - 775 & 850 - 875	H4Q89CS
Two Door Offset Quadrant	800x1000	750 - 775 & 950 - 975	H4Q810CS
Two Door Offset Quadrant	800x1200	750 - 775 & 1150 - 1175	H4Q812CS
Two Door Offset Quadrant	900x1200	850 - 875 & 1150 - 1175	H4Q912CS

FastFix
SYSTEM



900 x 1200mm Two Door Quadrant - H4Q912CS
Anti-Slip Quadrant Tray: RSQG129L
Shower Basket: RSB05

900 x 900mm Two Door Quadrant - H4Q9CS
Anti-Slip Quadrant Tray: RSQG90, Shower Basket: RSB05

One Door Quadrant

Features & Benefits

- Chromed brass handle
- 'Minimal' low profile seals
- Smooth running 'quick release' roller bearings
- 25mm vertical adjustment in each profile
- Matt Black sandblast finish renders product essentiality scratch-proof

Technical Information

Glass Thickness: 8mm

Total Height: 1950mm

Handing: Reversible

Colour options for hardware



Polished Chrome
add S to Codes

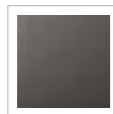

Matt Black
add B to Codes

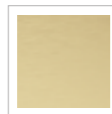

Brushed Brass
add BR to Codes

Please note:
Matt Black and Brushed Brass are available in Spring 2025

Description	Size (mm)	Adjustment (mm)	Code
One Door Quadrant	800x800	750 - 775	H4SQ8C
One Door Quadrant	900x900	850 - 875	H4SQ9C*
One Door Offset Quadrant	800x900	750 - 775 & 850 - 875	H4SQ89C
One Door Offset Quadrant	800x1000	750 - 775 & 950 - 975	H4SQ810C*
One Door Offset Quadrant	800x1200	750 - 775 & 1150 - 1175	H4SQ812C
One Door Offset Quadrant	900x1200	850 - 875 & 1150 - 1175	H4SQ912C

* Available in Matt Black & Brushed Brass.

FastFix
SYSTEM



1000mm Pivot Door - H4P10CS
800mm Side Panel - H4R8CS
Infinity Slate Tray: IGS108W, Shower Basket: RSB04

Pivot Door

Features & Benefits

- Chromed brass hinges and handle
- 'Minimal' low profile seals
- Pivot door must be hinged from the wall
- 25mm vertical adjustment in each profile
- Reversible for left or right hand fixing
- Matt Black sandblast finish renders product essentially scratch-proof

Technical Information

Glass Thickness: 8mm

Total Height: 1950mm

Handing: Reversible

Size (mm)	Adjustment (mm) Alcove Fitting	Adjustment (mm) Side Panel	Code
760	700 - 750	717 - 767	H4P76C*
800	740 - 790	757 - 807	H4P8C*
900	840 - 890	857 - 907	H4P9C*
1000	940 - 990	957 - 1007	H4P10C

* Available in Matt Black & Brushed Brass.

Description	Size (mm)	Adjustment (mm)	Code
Side Panel	700	640-690	H4R7C
Side Panel	760	710 - 735	H4R76C
Side Panel	800	750 - 775	H4R8C
Side Panel	900	850 - 875	H4R9C
Side Panel	1000	950 - 975	H4R10C
In-line Panel	200	+ 200mm to door sizes	H4HL2C
In-line Panel	300	+ 300mm to door sizes	H4HL3C
Extension Profile	1950 High	35mm extra	H4ZEX2
Mini-Extension Profile	1950 High	15mm extra	H4ZEX3

Colour options for hardware

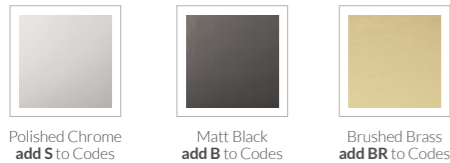

Polished Chrome
add S to Codes

Matt Black
add B to Codes

Brushed Brass
add BR to Codes

Please note:
Matt Black and Brushed Brass are available in Spring 2025

FullyAssembled
Easy to Install

Bi-Fold Door

Features & Benefits

- Chromed brass hinges and handle
- 25mm vertical adjustment in each profile
- Reversible for left or right hand fixing
- Smooth inward opening
- Matt Black sandblast finish renders product essentially scratch-proof

Technical Information

Glass Thickness: 6mm

Total Height: 1950mm

Handing: Reversible

Colour options for hardware

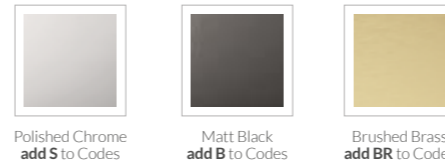

Polished Chrome
add S to Codes

Matt Black
add B to Codes

Brushed Brass
add BR to Codes

Please note:
Matt Black and Brushed Brass are available in Spring 2025

FullyAssembled
Easy to Install



1200mm Bi-Fold Door - H4B12CB
800mm Side Panel - H4R8CB
Anti-Slip Tray: IS1G128, Shower Basket: RSB07B



1700mm Sliding Door - H3S17CB
800mm Side Panel - H3R8CB
Anti-Slip Tray: RSTG178



1600mm Sliding Door - H3S16CS
800mm Side Panel: H3R8CS
Anti-Slip Tray: RSTG168, Shower Basket: RSB04

Sliding Door

Features & Benefits

- PVC / magnetic seals
- Chromed brass bolt through handle
- Chromed plastic top caps
- Smooth running bearing assemblies in the top and bottom rails
- 'Quick release bearings' in the bottom rail
- Reversible for left or right hand fixing
- Matt Black sandblast finish renders product essentiality scratch-proof

Technical Information

Glass Thickness: 6mm

Total Height: 1900mm

Handing: Reversible

Size (mm)	Adjustment (mm) Alcove Fitting	Adjustment (mm) Side Panel	Code
1000	940 - 990	966 - 1016	H3S10C*
1100	1040 - 1090	1066 - 1116	H3S11C*
1200	1140 - 1190	1166 - 1216	H3S12C*
1300	1240 - 1290	1266 - 1316	H3S13C
1400	1340 - 1390	1366 - 1416	H3S14C
1500	1440 - 1490	1466 - 1516	H3S15C
1600	1540 - 1590	1566 - 1616	H3S16C
1700	1640 - 1690	1666 - 1716	H3S17C

* Available in Matt Black & Brushed Brass.

Description	Size (mm)	Adjustment (mm)	Code
Side Panel	700	665 - 690	H3R7C
Side Panel	760	725 - 750	H3R76C
Side Panel	800	765 - 790	H3R8C
Side Panel	900	865 - 890	H3R9C
Side Panel	1000	965 - 990	H3R10C
In-line Panel	200	+ 200mm to door sizes	H3HL2C
In-line Panel	300	+ 300mm to door sizes	H3HL3C
Extension Profile	1900 High	40mm extra	H3ZEX
Mini-Extension Profile	1900 High	15mm extra	H3ZEX2

Colour options for hardware

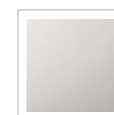

Polished Chrome
add **S** to Codes

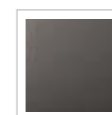

Matt Black
add **B** to Codes

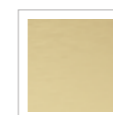

Brushed Brass
add **BR** to Codes



1700mm Level Access Sliding Door - H3LEL17CS (Left Hand)
Infinity Slate Tray: IGS178B
Shower Basket: RSB03

Level Access Sliding Door

Features & Benefits

- Easy release door function
- Chromed brass bolt through handle
- Chromed plastic top caps
- Smooth running bearing assemblies in the top rails
- Optional aluminium water guard strip (supplied)
- Right or left handing must be specified

Technical Information

Glass Thickness: 6mm

Total Height: 1900mm

Handing: Left or Right handing must be specified when ordering

Colour options for hardware

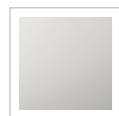

Polished Chrome

Size (mm)	Adjustment (mm) Alcove Fitting	Adjustment (mm) Side Panel	Code*
1000	940 - 990	976 - 1017	H3LEL10CS
1100	1040 - 1090	1076 - 1117	H3LEL11CS
1200	1140 - 1190	1176 - 1217	H3LEL12CS
1400	1340 - 1390	1376 - 1417	H3LEL14CS
1500	1440 - 1490	1476 - 1517	H3LEL15CS
1700	1640 - 1690	1676 - 1717	H3LEL17CS

* Please note: **Handing must be specified for the correct codes to be ordered.** The Code shows Left side, to order right side, please change the L to R, eg e.g H3LEL10CS to H3LER10CS

Description	Size (mm)	Adjustment (mm)	Code
Side Panel	700	665 - 690	H3R7CS
Side Panel	760	725 - 750	H3R76CS
Side Panel	800	765 - 790	H3R8CS
Side Panel	900	865 - 890	H3R9CS
Side Panel	1000	965 - 990	H3R10CS
Extension Profile	1900 High	40mm extra	H3ZEXS
Mini-Extension Profile	1900 High	15mm extra	H3ZEX2S

FastFix
SYSTEM

Corner Entry

Features & Benefits

- PVC / magnetic seals
- Chromed brass bolt through handles
- Chromed plastic top caps
- Smooth running bearing assemblies in the top and bottom rails
- 'Quick release bearings' in the bottom rail allows quick cleaning
- Reversible for left or right hand fixing

Technical Information

Glass Thickness: 6mm

Total Height: 1900mm

Handing: Reversible

Description	Size (mm)	Aperture (mm)	Adjustment (mm)	Code
Corner Entry	700 x 700	320	650 - 675	H3C7CS
Corner Entry	760 x 760	365	710 - 735	H3C76CS
Corner Entry	800 x 800	390	750 - 775	H3C8CS
Corner Entry	900 x 900	460	850 - 875	H3C9CS
Corner Entry	1000 x 1000	525	950 - 975	H3C10CS
Offset Corner Entry	700 x 900	395	650 - 675 & 850 - 875	H3C79CS
Offset Corner Entry	760 x 900	415	710 - 7735 & 850 - 875	H3C769CS
Offset Corner Entry	760 x 1000	455	710 - 735 & 950 - 975	H3C7610CS
Offset Corner Entry	800 x 900	430	750 - 775 & 850 - 875	H3C89CS
Offset Corner Entry	800 x 1000	465	750 - 775 & 950 - 975	H3C810CS
Offset Corner Entry	800 x 1200	550	750 - 775 & 1150 - 1175	H3C812CS

Colour options for hardware



Polished Chrome

FastFix
SYSTEM



1200 x 800mm Corner Entry - H3CB12CS
Anti-Slip Tray: RSTG128, Shower Basket: RSB07



Two Door Quadrant

Features & Benefits

- Tray Compatibility: 550mm radius
- Smooth running bearing assemblies in the top and bottom rails
- 'Quick release bearings' in the bottom rail
- Full length colourless PVC and magnetic seals
- Chromed brass handles on inside and outside of enclosure
- Chromed plastic top caps
- Easy Installation

Technical Information

Glass Thickness: 6mm

Total Height: 1900mm

Handing: Reversible

Colour options for hardware



Polished Chrome

Description	Size (mm)	Aperture (mm)	Adjustment (mm)	Code
Two Door Quadrant	800 x 800	380	765 - 790	H3Q8CS
Two Door Quadrant	900 x 900	510	865 - 890	H3Q9CS
Two Door Quadrant	1000 x 1000	510	965 - 990	H3Q10CS
Two Door Offset Quadrant	900 x 800	450	865 - 890 & 765 - 790	H3Q98CS
Two Door Offset Quadrant	1000 x 800	450	765 - 790 & 965 - 990	H3Q810CS
Two Door Offset Quadrant	1200 x 800	450	765 - 790 & 1165 - 1190	H3Q812CS
Two Door Offset Quadrant	1200 x 900	520	1165 - 1190 & 865 - 890	H3Q129CS

FastFix
SYSTEM

900 x 900mm Quadrant - H3SQ9CBR
Anti-Slip Quadrant Tray: RSQG90
Shower Basket: RSB02BR

One Door Quadrant

Features & Benefits

- Tray Compatibility: 550mm radius
- Smooth running bearing assemblies in the top and bottom rails
- 'Quick release bearings' in the bottom rail
- Full length colourless PVC and magnetic seals
- Chromed brass handles on inside and outside of enclosure
- Chromed plastic top caps
- Easy Installation
- Matt Black sandblast finish renders product essentiality scratch-proof

Technical Information

Glass Thickness: 6mm

Total Height: 1900mm

Handing: Reversible

Description	Size (mm)	Adjustment (mm)	Code
One Door Quadrant	900 x 900	865 - 890	H3SQ9C*
One Door Quadrant	1000 x 1000	965 - 990	H3SQ10C
One Door Offset Quadrant	900 x 800	865 - 890 & 765 - 790	H3SQ98C
One Door Offset Quadrant	1000 x 800	765 - 790 & 965 - 990	H3SQ810C*
One Door Offset Quadrant	1200 x 800	765 - 790 & 1165 - 1190	H3SQ812C
One Door Offset Quadrant	1200 x 900	1165 - 1190 & 865 - 890	H3SQ129C

* Available in Matt Black & Brushed Brass.

Colour options for hardware



Polished Chrome
add S to Codes



Matt Black
add B to Codes



Brushed Brass
add BBR to Codes

FastFix
SYSTEM



1200 x 900mm Two Door Offset Quadrant - H3Q129CSR
Anti-Slip Quadrant Tray: RSQG129R, Shower Basket: RSB06



800mm Pivot Door - H3P8CS
800mm Side Panel - H3R8CS
Anti-Slip Tray: RSTG80 Shower Basket: RSB06

Pivot Door

Features & Benefits

- Watertight magnetic seals
- Chromed brass bolt through handle
- Chromed plastic top caps
- Smooth operation hinges with chromed plastic cover caps
- Reversible for left or right hand fixing
- Matt Black sandblast finish renders product essentially scratch-proof

Technical Information

Glass Thickness: 6mm

Total Height: 1900mm

Handing: Reversible

Colour options for hardware

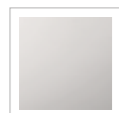

Polished Chrome
add **S** to Codes



Matt Black
add **B** to Codes

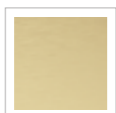

Brushed Brass
add **BR** to Codes

Size (mm)	Adjustment Alcove Fitting (mm)	Adjustment (mm) Side Panel	Code
700	640 - 690	666 - 716	H3P7C
760	700 - 750	726 - 776	H3P76C*
800	740 - 790	766 - 816	H3P8C*
900	840 - 890	866 - 916	H3P9C*
1000	940 - 990	966 - 1016	H3P10C

* Available in Matt Black & Brushed Brass.

Description	Size (mm)	Adjustment (mm)	Code
Side Panel	700	665 - 690	H3R7C
Side Panel	760	725 - 750	H3R76C
Side Panel	800	765 - 790	H3R8C
Side Panel	900	865 - 890	H3R9C
Side Panel	1000	965 - 990	H3R10C
In-line Panel	200	+ 200mm to door sizes	H3HL2C
In-line Panel	300	+ 300mm to door sizes	H3HL3C
Extension Profile	1900 High	40mm extra	H3ZEX
Mini-Extension Profile	1900 High	15mm extra	H3ZEX2

Bi-Fold Door

Features & Benefits

- Chromed plastic top caps
- Smooth running bearing assemblies running in the top and bottom rail
- Easy Installation
- Reversible for left or right hand fixing
- Smooth Inward opening
- Matt Black sandblast finish render product essentially scratch-proof

Technical Information

Glass Thickness: 4mm

Total Height: 1900mm

Handing: Reversible

Colour options for hardware



Polished Chrome
add **S** to Codes



Matt Black
add **B** to Codes



Brushed Brass
add **BR** to Codes

Size (mm)	Adjustment Alcove Fitting (mm)	Adjustment (mm) Side Panel	Code
760	700 - 750	730 - 780	H3B76C
800	740 - 790	770 - 820	H3B8C
900	840 - 890	870 - 920	H3B9C
1000	940 - 990	970 - 1020	H3B10C

Description	Size (mm)	Adjustment (mm)	Code
Side Panel	700	665 - 690	H3R7C
Side Panel	760	725 - 750	H3R76C
Side Panel	800	765 - 790	H3R8C
Side Panel	900	865 - 890	H3R9C
Side Panel	1000	965 - 990	H3R10C
In-line Panel	200	+ 200mm to door sizes	H3HL2C
In-line Panel	300	+ 300mm to door sizes	H3HL3C
Extension Profile	1900 High	40mm extra	H3ZEX
Mini-Extension Profile	1900 High	15mm extra	H3ZEX2

FullyAssembled
Easy to Install



800mm Bi-Fold Door - H3B8CS
Anti-Slip Tray: RSTG80, Shower Basket: RSB06



Frameless Pivot Door with In-Line Panel

Features & Benefits

- Watertight magnetic seals
- Chromed brass bolt through handle
- Chromed plastic top caps
- Smooth operation hinges with chromed plastic cover caps
- Reversible for left or right hand fixing
- Matt Black sandblast finish renders product essentially scratch-proof
- Outward & Inward opening

Technical Information

Glass Thickness: 6mm

Total Height: 1920mm

Handing: Reversible

Colour options for hardware



Polished Chrome
add **S** to Codes



Matt Black
add **B** to Codes

Corner Fitting

Description	Size (mm)	Aperture (mm)	Adjustment (mm)	Code
Door	665	600	-	H3FP1C
In-Line Panel	335	-	960 - 980	H3FHR10C
In-Line Panel	535	-	1160 - 1180	H3FHR12C
In-Line Panel	735	-	1360 - 1380	H3FHR14C
In-Line Panel	835	-	1460 - 1480	H3FHR15C
Side Panel	800	-	760 - 780	H3F2R8C
Side Panel	900	-	860 - 880	H3F2R9C

Alcove Fitting

Description	Size (mm)	Aperture (mm)	Adjustment (mm)	Code
Door	665	600	-	H3FP1C
In-Line Panel	335	-	950 - 990	H3FH10C
In-Line Panel	535	-	1150 - 1190	H3FH12C
In-Line Panel	735	-	1350 - 1390	H3FH14C
In-Line Panel	835	-	1450 - 1490	H3FH15C

Corner Fitting - Door: H3FPC8CS Side Panel: H3F1R8CS
Anti-Slip Tray: RSTG80

Frameless Pivot Door

Features & Benefits

- Chromed plastic top caps
- Smooth running bearing assemblies running in the top and bottom rail
- Easy Installation
- Reversible for left or right hand fixing
- Matt Black sandblast finish renders product essentially scratch-proof
- Outward opening only

Technical Information

Glass Thickness: 6mm

Total Height: 1920mm

Handing: Reversible

Colour options for hardware

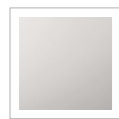

Polished Chrome
add **S** to Codes



Matt Black
add **B** to Codes

Corner Fitting

Description	Size (mm)	Aperture (mm)	Adjustment (mm)	Code
Door	760	640	715 - 735	H3FPC76C
Door	800	680	755 - 775	H3FPC8C
Door	900	780	855 - 875	H3FPC9C
Side Panel	760	-	720 - 740	H3F1R76C
Side Panel	800	-	760 - 780	H3F1R8C
Side Panel	900	-	860 - 880	H3F1R9C

Alcove Fitting

Size (mm)	Aperture (mm)	Adjustment (mm)	Code
760	600	710 - 750	H3FP76C
800	640	750 - 790	H3FP8C
900	740	850 - 890	H3FP9C



Frameless Pivot Door with In-line Panel
Door: H3FP1CB, In-Line Panel: H3FHR12CB, Side Panel: H3F2R8CB
Anti-Slip Tray: RSTG12B

Haven Framed *Collection*



1200mm Sliding Door - H5S12CS
900mm Side Panel - H5R9CS
Anti-Slip Tray: RSTG129, Shower Basket: RSB07

Sliding Door

Features & Benefits

- Fully framed door with magnetic closing mechanism and cushioned seals
- Full length integral handle on inside and outside of door
- Reversible for left or right hand fixing

Technical Information

Glass Thickness: 4mm
Total Height: 1900mm
Handing: Reversible

Colour options for hardware

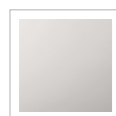

Polished Chrome

Size (mm)	Adjustment (mm) Alcove Fitting	Adjustment (mm) Side Panel	Code
1000	935 - 995	937 - 997	H5S10CS
1100	1035 - 1095	1037 - 1097	H5S11CS
1200	1135 - 1195	1137 - 1197	H5S12CS

Description	Size (mm)	Adjustment (mm)	Code
Side Panel	700	630-690	H5R7CS
Side Panel	760	690-750	H5R76CS
Side Panel	800	730-790	H5R8CS
Side Panel	900	830-890	H5R9CS
Side Panel	1000	930-990	H5R10CS
Side Panel	1200	1130-1190	H5R12CS
In-line Panel	200	+285mm to door size	H5HL2CS
In-line Panel	300	+335mm to door size	H5HL3CS
In-line Panel	400	+410mm to door size	H5HL4CS
Extension Profiles	-	-	H5ZEXS

FullyAssembled
Easy to Install

Pivot Door

Features & Benefits

- Fully framed door with magnetic closing mechanism
- Full length integral handle on inside and outside of door
- Full length cushion seals and deflector guide
- Outward opening doors must be hinged from the wall only
- Reversible for left or right hand fixing

Technical Information

Glass Thickness: 4mm
Total Height: 1900mm
Handing: Reversible

Size (mm)	Adjustment (mm) Alcove Fitting	Adjustment (mm) Side Panel	Code
700	635 - 695	637 - 697	H5P7CS
760	695 - 755	697 - 757	H5P76CS
800	735 - 795	737 - 797	H5P8CS
900	835 - 895	837 - 897	H5P9CS

Description	Size (mm)	Adjustment (mm)	Code
Side Panel	700	630-690	H5R7CS
Side Panel	760	690-750	H5R76CS
Side Panel	800	730-790	H5R8CS
Side Panel	900	830-890	H5R9CS
Side Panel	1000	930-990	H5R10CS
Side Panel	1200	1130-1190	H5R12CS
In-line Panel	200	+285mm to door size	H5HL2CS
In-line Panel	300	+335mm to door size	H5HL3CS
In-line Panel	400	+410mm to door size	H5HL4CS
Extension Profiles	-	-	H5ZEXS

FullyAssembled
Easy to Install



900mm Pivot Door - H5P9CS
Anti-Slip Tray: RSTG90, Shower Basket: RSB07



1000mm Bi-Fold Door - H5B10CS
Anti-Slip Tray: RSTG108, Shower Basket

Bi-Fold Door

Features & Benefits

- Fully framed door with magnetic closing mechanism and cushioned seals
- Full length integral handle on inside and outside of door
- Precision roller bearing mechanism for smooth sliding action
- Reversible for left or right hand fixing

Technical Information

Glass Thickness: 4mm

Total Height: 1900mm

Handing: Reversible

Colour options for hardware



Polished Chrome

Size (mm)	Adjustment Alcove Fitting (mm)	Adjustment Side Panel (mm)	Code
700	645 - 705	647 - 707	H5B7CS
760	675 - 735	677 - 737	H5B76CS
800	735 - 795	737 - 797	H5B8CS
900	825 - 885	827 - 887	H5B9CS
1000	930 - 990	932 - 992	H5B10CS
1200	1140 - 1200	1142 - 1202	H5B12CS

Description	Size (mm)	Adjustment (mm)	Code
Side Panel	700	630-690	H5R7CS
Side Panel	760	690-750	H5R76CS
Side Panel	800	730-790	H5R8CS
Side Panel	900	830-890	H5R9CS
Side Panel	1000	930-990	H5R10CS
Side Panel	1200	1130-1190	H5R12CS
In-line Panel	200	+285mm to door size	H5HL2CS
In-line Panel	300	+335mm to door size	H5HL3CS
In-line Panel	400	+410mm to door size	H5HL4CS
Extension Profiles	-	-	H5ZEXS

FullyAssembled
Easy to Install

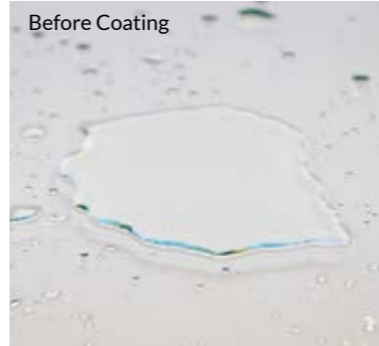

ULTRA CARE

All Roman's enclosures and bath screens are pre-coated with Roman Ultra Care, our own unique glass protection system. Pre-coated glass protection systems will always diminish in their effectiveness over time, depending on how often the shower is used and how often it is cleaned. Unlike other systems, Roman Ultra Care in a bottle can be used in tandem with the pre-coat to build up the effectiveness and make it stronger the more you clean.

This results in the protected surface remaining easy to clean by simply applying a mild detergent and wiping with a damp cloth or using a Roman Shower Blade.

By topping up the glass protection system with Roman Ultra Care in a bottle every time you clean, you can significantly reduce the amount of time required to clean your enclosure and bathroom surfaces. Most importantly, you can considerably prolong the life of your Roman product and at the same time do your bit for the environment by eliminating the use of harsh and damaging cleaning products.

946ml Bottle Code: RUC03

Buy online at www.romanathome.com



Make cleaning your bathroom easy with our

Shower, Tile & Bath Restoration and Maintenance Kit

- Eliminates hard water and soap scum build-up
- Clean and protect your shower in minutes
- Restore discoloured glass and maintain the sparkle of your bathroom

3 Step System includes:

Ultra Scrub
Surface Stain Cleanser

Designed to effectively and easily clean your bathroom surfaces, including Glass, Porcelain, Ceramics and other hard surfaces.

Developed to remove the build-up of minerals, rust, soaps, oils and limescale but without damaging the surface.

Ultra Shield
Glass and Surface Stain Cleanser

Formulated to clean and protect. Ultra Shield can be used on your bathroom surfaces to create a water, soil and stain repellent barrier coating which prevents water, soil and grime from sticking for easier cleaning. This barrier is renewed with each use.

Ultra Care
Glass and Surface Protector

For a long lasting sparkle on bathroom and shower surfaces. Ultra Care is the ultimate surface protector that repels the build-up. Also available in large bottle for ongoing aftercare.



Kit code: RUC14

For details of your nearest stockist please contact Roman Customer Relations on 01325 328033 or buy online at www.romanathome.com



Wetroom Panels

Collection

Wetroom shower panels are a more open alternative to a shower enclosure, which usually consist of just one glass panel. This can either be positioned in a corner or on a straight wall. Wetroom panels can be installed onto a shower tray, or installed straight down to floor.

Roman's unrivalled Wetroom Collection offers a variety of heights, shapes, glass thicknesses, colours and price points – with a multitude of design options to choose from.



Liberty Black Grid

Wetroom Panels with Matt Black Finish

Features & Benefits

- Matt Black sandblast finish renders product essentially scratch-proof
- Glass filled paint fired into the glass during toughening
- Vertical adjustment: $\pm 7.5\text{mm}$
- Tray compatibility: Tray or straight to floor using a wetroom system
- Additional deflector panel moves the wet area into the shower tray
- Glass filled paint fired into the glass during toughening

Technical Information

Glass Thickness: 10mm

Total Height: 2000mm

Handing: Reversible

Corner Panels

Description	Size (mm)	Adjustment (mm)	Code
Black Grid Corner Panel	757	$\pm 7.5\text{mm}$	KLCP8GPB
Black Grid Corner Panel	857	$\pm 7.5\text{mm}$	KLCP9GPB
Black Grid Corner Panel	957	$\pm 7.5\text{mm}$	KLCP10GPB
Black Grid Corner Panel	1057	$\pm 7.5\text{mm}$	KLCP11GPB
Black Grid Corner Panel	1157	$\pm 7.5\text{mm}$	KLCP12GPB
Black Grid Pivoting Deflector Panel	343	N/A	KLSPM3GPB

Brace Bars

Description	Size (mm)	Adjustment (mm)	Code
Low Level Brace Kit	1030	Cut to suit	LBBK4590SQB
Side Panel Brace Kit - use with LBBK4590SQB	1000	Cut to suit	LBBKT90SQB
Ceiling Brace Kit	1030	Cut to suit	LBBKC50SQB

Colour options for hardware

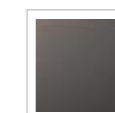

Matt Black

Please note: All colours are available on request.



Matt Black sandblast finish renders product essentially scratch-proof

1600 x 800 Corner Fitting - Brushed Nickel
 Corner Panel: KLCP813N (x2), Pivoting Deflector Panel: KLSPM313N
 Brace Bar: LBBKC505QN, Infinity Slate Tray: IGS168

Liberty Wetroom Panels with Clear Glass

Features & Benefits

- Choice of colour finishes
- Vertical adjustment: ±7.5mm
- Tray compatibility: Tray or straight to floor using a wetroom system
- Additional deflector panel moves the wet area into the shower tray
- Matt Black sandblast finish renders product essentially scratch-proof

Technical Information

Glass Thickness: 10mm
Total Height: 2000mm
Handing: Reversible

Colour options for hardware



Polished Chrome add S to Codes
 Matt Black add B to Codes
 Brushed Brass add BR to Codes
 Brushed Nickel add N to Codes
 Polished Nickel add PN to Codes
 Matt White add W to Codes



Panels

Description	Size (mm)	Adjustment (mm)	Code
Clear Glass Corner Panel	757	±7.5mm	KLCP813
Clear Glass Corner Panel	857	±7.5mm	KLCP913
Clear Glass Corner Panel	957	±7.5mm	KLCP1013
Clear Glass Corner Panel	1057	±7.5mm	KLCP1113
Clear Glass Corner Panel	1157	±7.5mm	KLCP1213
Clear Glass Pivoting Deflector Panel	343	N/A	KLSPM313

Square Brace Bars

Description	Size (mm)	Adjustment (mm)	Code for Polished Chrome*
Low Level Brace Kit	1030	Cut to suit	LBBK4590SQ
Side Panel Brace Kit - use with LBBK4590SQ	1000	Cut to suit	LBBKT90SQ
Ceiling Brace Kit	1030	Cut to suit	LBBKC505SQ

*Please note: The code shown as Polished Chrome, add other colour letter to codes.



Liberty Wetroom Panels with Fluted Glass

Features & Benefits

- Vertical adjustment: ± 7.5 mm
- Optional pivoting deflector panel
- Choice of colour finishes available
- Tray compatibility: Tray or straight to floor using a wetroom System
- Additional deflector panel moves the wet area into the shower tray
- Matt Black sandblast finish renders product essentially scratch-proof

Technical Information

- Glass Thickness:** 8mm
- Total Height:** 2000mm
- Handing:** Reversible

Panels

Description	Size (mm)	Adjustment (mm)	Code
Fluted Glass Corner Panel	757	± 7.5 mm	KLCP8F
Fluted Glass Corner Panel	857	± 7.5 mm	KLCP9F
Fluted Glass Corner Panel	957	± 7.5 mm	KLCP10F
Fluted Glass Corner Panel	1057	± 7.5 mm	KLCP11F
Fluted Glass Corner Panel	1157	± 7.5 mm	KLCP12F
Fluted Glass Pivoting Deflector Panel	343	N/A	KLSPM3F

Square Brace Bars

Description	Size (mm)	Adjustment (mm)	Code for Polished Chrome*
Low Level Brace Kit	1030	Cut to suit	LBBK4590SQ
Side Panel Brace Kit - use with LBBK4590SQ	1000	Cut to suit	LBBKT90SQ
Ceiling Brace Kit	1030	Cut to suit	LBBKC50SQ

*Please note: The code shown as Polished Chrome, add other colour letter to codes.

Colour options for hardware



1700 x 800 Corner-Fitting - Polished Chrome
 Corner Panel: KLCP12FS, Corner Panel: KLCP8FS
 Deflector Pivoting Panel: KLSPM3FC, Brace Bar: LBBK4590SQS
 Anti Slip Tray: RSTG178



Innov8

Framed Wetroom Panel with Clear or Fluted Glass

Features & Benefits

- Fully framed in choice of colour
- Back to wall or ceiling brace options
- Matt Black sandblast finish renders product essentially scratch-proof

Technical Information

- Glass Thickness:** 8mm
- Total Height:** 2032mm
- Handing:** Reversible

Panels

Size (mm)	Glass	Adjustment (mm)	Code
700	Clear	695-720	N2SP713
800	Clear	795-820	N2SP813
900	Clear	895-920	N2SP913
1000	Clear	995-1020	N2SP1013
1200	Clear	1195-1220	N2SP1213
700	Fluted	695-720	N2SP7F
800	Fluted	795-820	N2SP8F
900	Fluted	895-920	N2SP9F
1000	Fluted	995-1020	N2SP10F
1200	Fluted	1195-1220	N2SP12F

Square Brace Bars

Description	Size (mm)	Adjustment (mm)	Code for Polished Chrome*
Back to Wall Brace Kit	1030	Cut to suit	NBBK90SQ
Ceiling Brace Kit	1030	Cut to suit	NBBKC50SQ

*Please note: The code shown as Polished Chrome, add other colour letter to codes.

Colour options for hardware

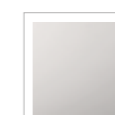

Polished Chrome
add **S** to Codes

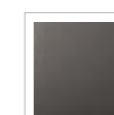

Matt Black
add **B** to Codes

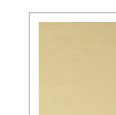

Brushed Brass
add **BBR** to Codes

1000 Panel with fluted glass - Matt Black
Corner Panel: N2SP10FB
Back to Wall Brace Kit: NBBK90SQB, Anti Slip Tray: RSTG158



Innov8

Pivoting Wetroom Panel

Features & Benefits

- Frameless panels with 180° pivoting action
- Chromed brass top caps
- Inward & Outward opening
- Tray compatibility: Tray or straight to floor using a wetroom System
- Additional deflector panel moves the wet area into the shower tray
- Compatible trays available
- Matt Black sandblast finish renders product essentially scratch-proof

Technical Information

Glass Thickness: 8mm

Total Height: 1967mm

Handing: Reversible

Size (mm)	Adjustment (mm)	Code
400	360-380mm	N2FSPM413
500	460-480mm	N2FSPM513
800	760-780mm	N2FSPM813
900	860-880mm	N2FSPM913



1600 x 800 Pivoting Panel - Polished Chrome
 Pivoting Panel: N2FSPM813S
 Anti-Slip Tray: RSTG168
 Shower Basket RSB07

Colour options for hardware

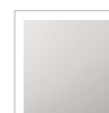

Polished Chrome
add S to Codes

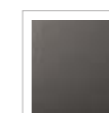

Matt Black
add B to Codes

Please note - lead time 10 - 14 days.

Innov8 Folding Wetroom Panels

Features & Benefits

- Frameless folding panels with 180° pivoting action
- Tray compatibility: Tray or straight to floor using a wetroom System
- Additional deflector panel moves the wet area into the shower tray
- Chromed brass hinges
- Chromed brass top caps

Technical Information

- Glass Thickness:** 8mm
- Total Height:** 1967mm
- Handing:** Reversible

Size (mm)	Adjustment (mm)	Code
800	760 - 780	N2VC813S
900	860 - 880	N2VC913S
1000	960 - 980	N2VC1013S

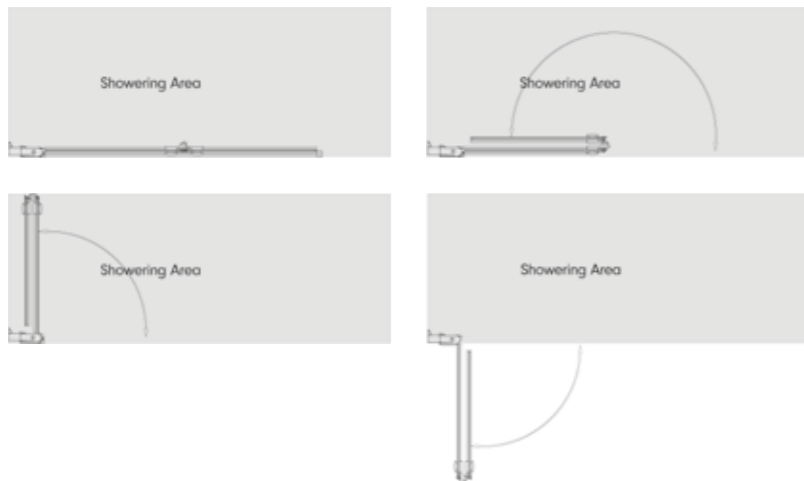

1000 Wetroom Panel - Polished Chrome
Bi-Fold Panel: N2VC1013S
Shower Basket R5B07

Colour options for hardware



Polished Chrome



Haven Select

Wetroom Panels

The perfect way to create a wetroom - tailored to your own style

1700 x 800 3 Sided Fitting - Polished Chrome
Corner Panel H8SPAC3CS
Glass to Glass Panel H8FP9CS
Pivoting Deflector Panel H8SPM3CS
Brace Bars HBBKC50SQ, HBBK4590SQ
Shower Basket RSB01



Water is the driving force of all nature
- Leonardo da Vinci



900 Corner Panel × 2 - H8SP9GPB,
Deflector Panel - H8SPM3GPB
Infinity Slate Tray: IGS169W

WETROOM PANELS

Haven Select

Black Grid Wetroom Panel

Features & Benefits

- Vertical adjustment: ±7.5mm
- Tray compatibility: Tray or straight to floor using a wetroom system
- Glass filled paint fired into the glass during toughening
- Additional deflector panel moves the wet area into the shower tray
- Matt Black sandblast finish renders product essentially scratch-proof

Technical Information

Glass Thickness: 8mm
Total Height: 2000mm
Handing: Reversible

Colour options for hardware

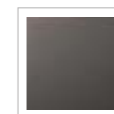

Matt Black

Please note: All colours are available on request.

Panels

Description	Size (mm)	Actual Size (mm)	Adjustment (mm)	Code
Black Grid Wetroom Panel	800	765	+/- 7.5mm	H8SP8GPB
Black Grid Wetroom Panel	900	865	+/- 7.5mm	H8SP9GPB
Black Grid Wetroom Panel	1000	965	+/- 7.5mm	H8SP10GPB
Black Grid Wetroom Panel	1100	1065	+/- 7.5mm	H8SP11GPB
Black Grid Wetroom Panel	1200	1165	+/- 7.5mm	H8SP12GPB
Pivoting Deflector Panel	300	343	N/A	H8SPM3GPB

Square Brace Bars

Description	Max Size (mm)	Code
Low Level Brace Kit*	1030	HBBK4590SQB
Side Panel Brace Kit - use with HBBK4590SQB	1000	HBBKT90SQB
Ceiling Brace Kit	1030	HBBKC50SQB
Floor to Ceiling Brace Kit	2700 high	HF2C8KITSQB





1700 x 800 2 sided wetroom - Brushed Brass
 900mm Corner Panel: H10SP9CBR
 800mm Corner Panel: H10SP8CBR
 Floor to Ceiling Brace Bar: HF2C8KITSQBR
 Brushed Brass Shower Basket: RSB01BR
 Infinity Slate Tray: IGS178W



WETROOM PANELS

Haven Select Wetroom Panels

Roman's Haven Select Collection features our Wetroom Panel options, which can be fitted to our low level shower trays or straight to floor to create a true wetroom. We present a number of panel sizes and options, to help you create your perfect bathroom sanctuary. Included are the various configurations that are available to suit you and your bathroom.

All Panels are 2000mm high and available in either 8mm glass thickness or 10mm glass thickness. Bracing is recommended for use with all wet room panel sizes.

Features & Benefits

- Reversible for left or right hand applications
- Suitable for use with power showers
- Stylish brace bars and fixed or pivoting return panels can be purchased separately if required. An adjustable foot is supplied with the fixed return panel for extra support
- Matt Black sandblast finish renders product essentially scratch-proof

Technical Information

Glass Thickness: 8mm, 10mm
Total Height: 2000mm

Vinyl Floor Contour Profile Kit

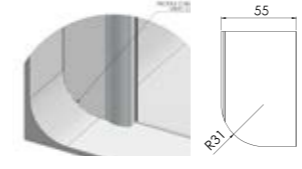

Extension Profile

Thickness: 8mm, 10mm
Adjustment Size: 0-35mm
Colour finishes: Polished Chrome, Matt Black

Colour options for hardware

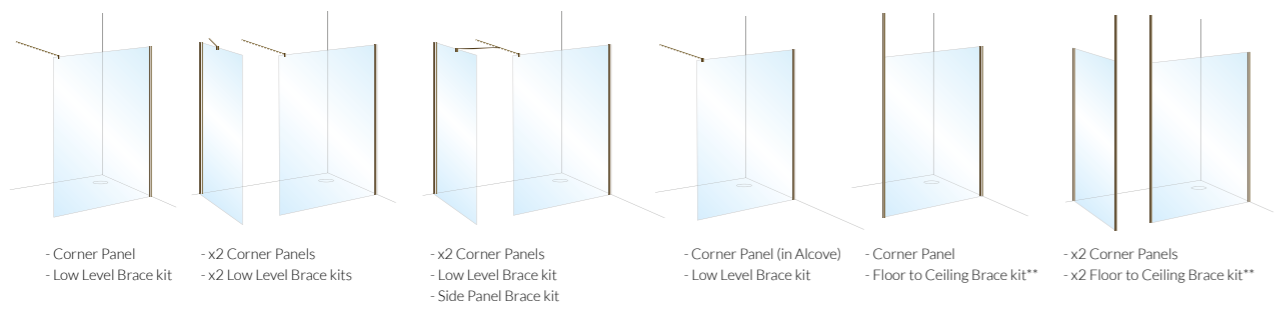
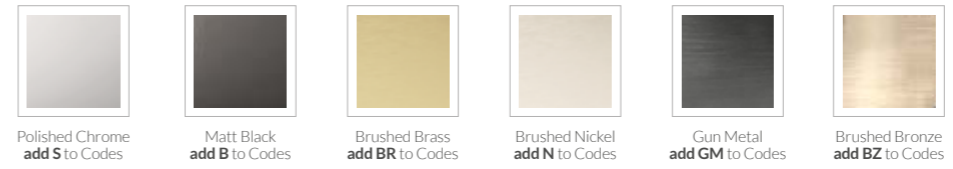

Please note:
 * Only available for Polished Chrome and Matt Black
 ** Not available in Gun Metal and Brushed Bronze

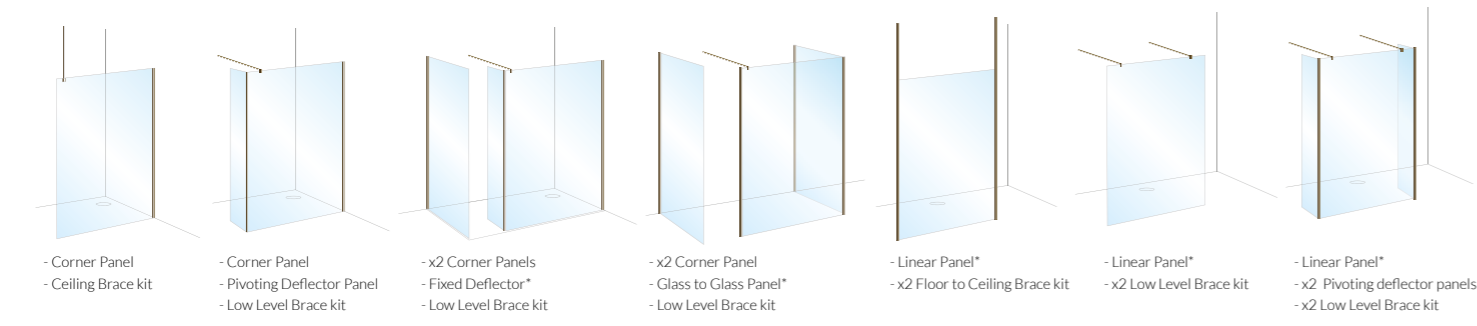

Description	Polished Chrome	Matt Black	Brushed Brass	Brushed Nickel	Gun Metal	Brushed Bronze	8mm Glass		10mm Glass		
							Actual Width (mm)	Code	Actual Width (mm)	Code	
Corner Panels (includes wall fixing kit allowing +/- 7.5mm of vertical adjustment).											
400 Corner Panel	•	•	•	•	•	•	365	H8SP4C	350	H10SP4C	
500 Corner Panel	•	•	•	•	•	•	465	H8SP5C	450	H10SP5C	
600 Corner Panel	•	•	•	•	•	•	565	H8SP6C	550	H10SP6C	
700 Corner Panel	•	•	•	•	•	•	665	H8SP7C	650	H10SP7C	
760 Corner Panel	•	•	•	•	•	•	725	H8SP76C	710	H10SP76C	
800 Corner Panel	•	•	•	•	•	•	765	H8SP8C	750	H10SP8C	
900 Corner Panel	•	•	•	•	•	•	865	H8SP9C	850	H10SP9C	
1000 Corner Panel	•	•	•	•	•	•	965	H8SP10C	950	H10SP10C	
1100 Corner Panel	•	•	•	•	•	•	1065	H8SP11C	1050	H10SP11C	
1200 Corner Panel	•	•	•	•	•	•	1165	H8SP12C	1150	H10SP12C	
1400 Corner Panel	•	•	•	•	•	•	1365	H8SP14C	1350	H10SP14C	
Deflector Panel (includes fixed or pivoting corner fixing kit). - Inward Opening only											
200 Fixed Deflector Panel	•	•	-	-	-	-	226	H8SPL2C	226	H10SPL2C	
200 Pivoting Deflector Panel	•	•	•	•	•	•	243	H8SPM2C	243	H10SPM2C	
300 Pivoting Deflector Panel	•	•	•	•	•	•	343	H8SPM3C	343	H10SPM3C	
400 Pivoting Deflector Panel	•	•	•	•	•	•	443	H8SPM4C	443	H10SPM4C	
Linear Panel (includes freestanding floor fixing kit).											
1000 Linear Panel	•	•	-	-	-	-	955	H8LP10C	940	H10LP10C	
1100 Linear Panel	•	•	-	-	-	-	1055	H8LP11C	1040	H10LP11C	
1200 Linear Panel	•	•	-	-	-	-	1155	H8LP12C	1140	H10LP12C	
1400 Linear Panel	•	•	-	-	-	-	1355	H8LP14C	1340	H10LP14C	
Glass to Glass Panel (includes freestanding floor fixing kit).											
600 Glass to Glass Panel	•	•	-	-	-	-	567	H8FP6C	556	H10FP6C	
700 Glass to Glass Panel	•	•	-	-	-	-	667	H8FP7C	656	H10FP7C	
760 Glass to Glass Panel	•	•	-	-	-	-	727	H8FP76C	716	H10FP76C	
800 Glass to Glass Panel	•	•	-	-	-	-	767	H8FP8C	756	H10FP8C	
900 Glass to Glass Panel	•	•	-	-	-	-	867	H8FP9C	856	H10FP9C	
1000 Glass to Glass Panel	•	•	-	-	-	-	967	H8FP10C	956	H10FP10C	
1100 Glass to Glass Panel	•	•	-	-	-	-	1067	H8FP11C	1056	H10FP11C	
1200 Glass to Glass Panel	•	•	-	-	-	-	1167	H8FP12C	1156	H10FP12C	



1200 x 800 Wetroom Panels - Gun Metal
 1200mm Corner Panel: H8SP12FCGM, 800mm Corner Panel: H8SP8FCGM
 300mm Deflector Panel: H8SPM3FCGM
 Brace Bars: HBBKT90SQGM, HBBK4590SQGM
 Infinity Slate Tray: IGS168B

Haven Select

Wetroom Panels with Fluted Glass

Features & Benefits

- Reversible for left or right hand applications
- Suitable for use with power showers
- Stylish brace bars and fixed or pivoting return panels can be purchased separately if required. An adjustable foot is supplied with the fixed return panel for extra support
- Matt Black sandblast finish renders product essentially scratch-proof

Technical Information

Glass Thickness: 8mm

Total Height: 2000mm

Description	Glass Thickness	Actual Width (mm)	Code
Corner Panels			
800 Corner Panel	8mm	765	H8SP8FC
900 Corner Panel	8mm	865	H8SP9FC
1000 Corner Panel	8mm	965	H8SP10FC
1100 Corner Panel	8mm	1065	H8SP11FC
1200 Corner Panel	8mm	1165	H8SP12FC
Deflector Panel (180° Movement Inward Opening only)			
300 Pivoting Deflector Panel	8mm	343	H8SPM3FC

Haven Select Bracing Bars



Round Bracing Bars

Description	Max Size (mm)	Adjustment (mm)	Code for Polished Chrome
Low Level Brace Kit	1030	Cut to suit	HBBK4590
Side Panel Brace Kit (use with HBBK4590)	1000	Cut to suit	HBBKT90
Ceiling Brace Kit	1030	Cut to suit	HBBKC50
Floor to Ceiling Brace Kit †	2700 high	Cut to suit	HF2C8KIT
Low Level Brace Kit (90° only)	1030	Cut to suit	HBBK90*
Mini Ceiling Brace Kit	118	Cut to suit	HBBKMC01*

* Please note: Matt Black is available for **Low Level Brace Kit (90° only)** and **Mini Ceiling Brace kit**, add **B** at the end code. † Only available for 8mm glass.



Square Bracing Bars

Description	Max Size (mm)	Code for Polished Chrome	Code for other colours Add B, BR, N, GM, BZ
Low Level Brace Kit*	1030	HBBK4590SQ	HBBK4590SQ
Side Panel Brace Kit (use with HBBK4590)	1000	HBBKT90SQ	HBBKT90SQ
Ceiling Brace Kit	1030	HBBKC50SQ	HBBKC50SQ
Floor to Ceiling Brace Kit †	2700 high	HF2C8KITSQ	HF2C8KITSQ**

*For use straight back to wall or can be cut to 45° if required for corner fixing as illustrated in 1 and 1(b). N.B. Adjustments are measured from the wall to the inside of the glass.

** Not available in Gun Metal and Brushed Bronze. † Only available for 8mm glass.



Colour options for hardware





1200 x 800 Wetroom Panels Fluted Glass - Brushed Bronze
1200mm Corner Panel: H8SP12FCBZ, 800mm Corner Panel: H8SP8FCBZ
300mm Deflector Panel: H8SPM3FCBZ
Brace Bars: HBBKT90SQBZ, HBBK4590SQBZ
Infinity Slate Tray: IGS168B



Shower Trays

Collection

Our luxury range of Shower Trays offers the user a choice of installations and shapes and sizes depending on the desired finish.

Our range of low profile Shower Trays are manufactured from solid surface material with a gel coat finish and are naturally Anti-Slip, to the highest standard.

The tray waste is available in a choice of colour finishes to match your bathroom's brassware and shower enclosure – Polished Chrome, Brushed Brass, Matt Black, Brushed Nickel and White.

The Infinity Slate Shower Trays have an authentic slate finish with a textured surface and a stylish load bearing linear waste cover.

Anti-Slip Tray

Features & Benefits

- Anti-slip surface to DIN Class C
- Solid surface with Gel Coat Finish
- Fully recyclable
- Height 40mm
- Chrome 90mm Fast Flow waste included (Colour Options Available)
- Self levelling kit included
- Tray and feet options
- Riser kit can be bought separately

Chrome Waste included with Tray



1800 x 800 Anti-Slip Tray - RSTG188

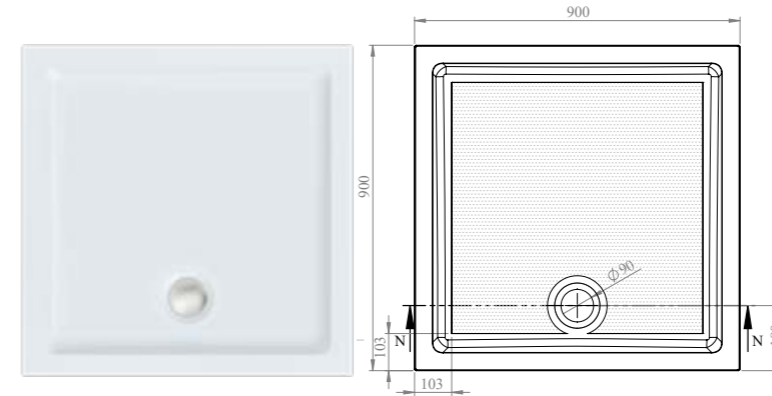

900 x 900 Anti-Slip Tray - RSTG90



1800 x 800 Anti-Slip Tray - RSTG188

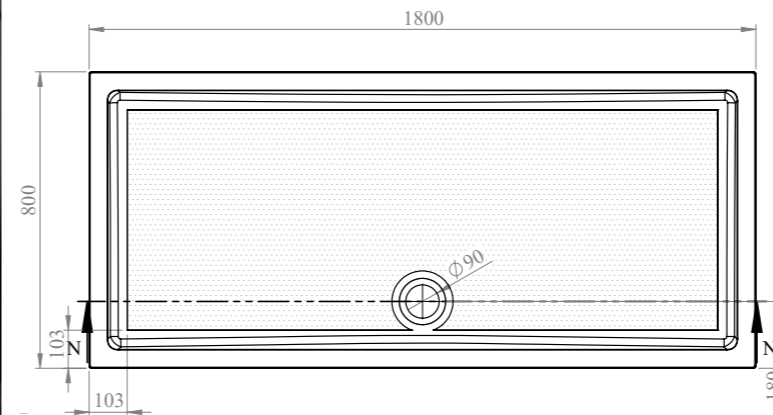

Riser Kit Height: 100mm

Colour for Trays Finish

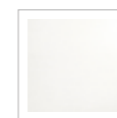

White

Square Trays

Width (mm)	Depth (mm)	Height (mm)	Code
700	700	40	RSTG70
760	760	40	RSTG76
800	800	40	RSTG80
900	900	40	RSTG90

Rectangular Trays

Width (mm)	Depth (mm)	Height (mm)	Code
800	700	40	RSTG87
900	700	40	RSTG97
900	760	40	RSTG976
900	800	40	RSTG98
1000	700	40	RSTG107
1000	800	40	RSTG108
1000	900	40	RSTG109
1100	800	40	RSTG118
1200	700	40	RSTG127
1200	760	40	RSTG1276
1200	800	40	RSTG128
1200	900	40	RSTG129
1300	800	40	RSTG138
1400	700	40	RSTG147
1400	800	40	RSTG148
1400	900	40	RSTG149
1500	800	40	RSTG158
1500	900	40	RSTG159
1600	700	40	RSTG167
1600	800	40	RSTG168
1600	900	40	RSTG169
1700	700	40	RSTG177
1700	760	40	RSTG1776
1700	800	40	RSTG178
1700	900	40	RSTG179
1800	800	40	RSTG188



Anti-Slip Quadrant Tray

Chrome Waste included with Tray

Features & Benefits

- Anti-slip surface to DIN Class C
- Solid surface with Gel Coat Finish
- Fully recyclable
- Self levelling kit included
- Tray and feet options
- Riser kit can be bought separately
- Chrome 90mm Fast Flow waste included (Colour Options Available)

Quadrant

Width (mm)	Depth (mm)	Height (mm)	Code
800	800	40	RSQG80
900	900	40	RSQG90

Offset Quadrant

Width (mm)	Depth (mm)	Height (mm)	Handing	Code
1000	800	40	Left Hand	RSQG108L
1000	800	40	Right Hand	RSQG108R
1200	800	40	Left Hand	RSQG128L
1200	800	40	Right Hand	RSQG128R
1200	900	40	Left Hand	RSQG129L
1200	900	40	Right Hand	RSQG129R

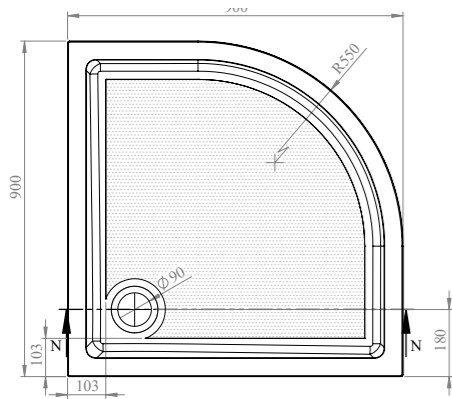

900 x 900 Anti-Slip Quadrant Tray - RSQG90



1200 x 800 Anti-Slip Quadrant Tray - Left Hand - RSQG128L

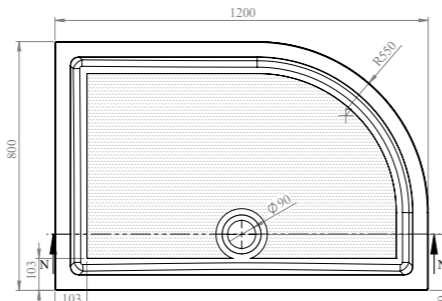

Left Hand



Colour for Trays Finish



White



Tray Waste & Cover Cap

Technical Information

Diameter: 90mm

The waste flow rate: 39 LPM



The waste flow rate is 39 LPM (litres per minute)

Colour	Code
Tray waste & Polished Chrome Cap	RDTW01
Tray waste Cap - White	RDTWCW
Tray waste Cap - Matt Black	RDTWCB
Tray waste Cap - Brushed Brass	RDTWCBR
Tray waste Cap - Brushed Nickel	RDTWCN



Waste Cover Cap - Polished Chrome

Waste Cover Cap - White

Waste Cover Cap - Matt Black

Waste Cover Cap - Brushed Brass

Waste Cover Cap - Brushed Nickel

Riser Kits

Available use for Anti-Slip and Anti-Slip Quadrant Trays



Square & Rectangular

Description	Height	Code
Riser Kit for RSTG70 - RSGT118	100mm	RSTGRK01
Riser Kit for RSTG127 - RSTG179	100mm	RSTGRK02
Riser Kit for RSTG188	100mm	RSTGRK03

Quadrant

Description	Height	Code
Riser Kit for Quadrant	100mm	RSQGRK02

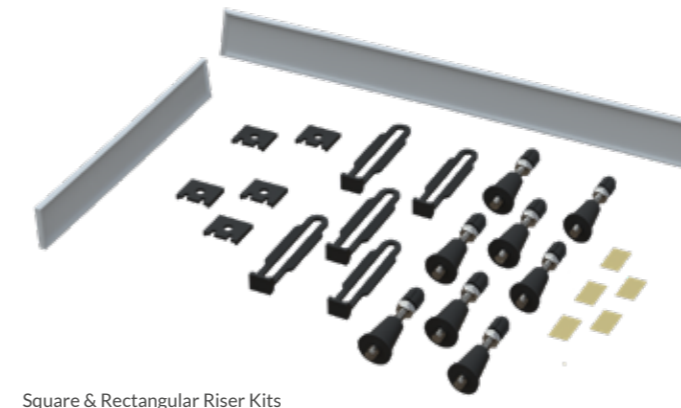

Square & Rectangular Riser Kits



Quadrant Riser Kits



1700 x 700 Right Hand - RCG177R

Neo Angle Tray

Chrome Waste included with Tray

Size: 900 x 900, 1200 x 900mm
 Height: 40mm

Width (mm)	Depth (mm)	Height (mm)	Handing	Code
900	900	40	—	RNG90
1200	900	40	Left Hand	RNG129L
1200	900	40	Right Hand	RNG129R

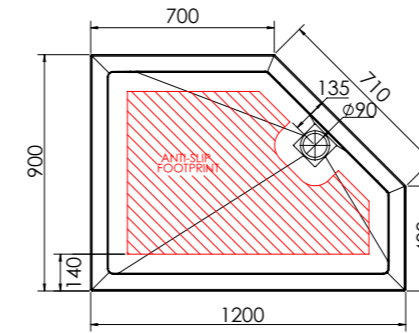

Left Hand

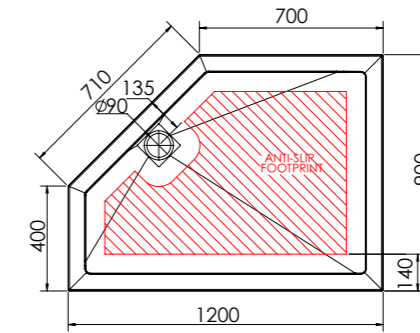

Right Hand

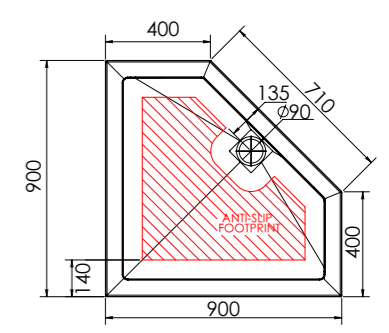

Colour for Trays Finish



White



Innov8 Walk-in Shower Tray

Chrome Waste included with Tray

Size: 1700 x 700mm
 Height: 50mm

Width (mm)	Depth (mm)	Height (mm)	Handing	Code
1700	700	50	Left Hand	RCG177L
1700	700	50	Right Hand	RCG177R

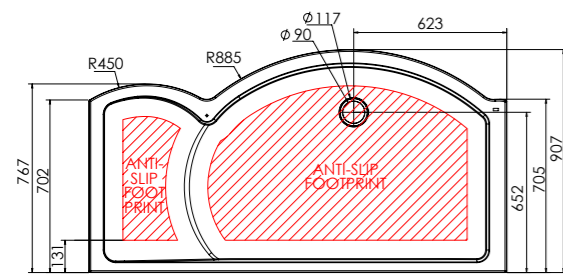

Left Hand



Left Hand

Colour for Trays Finish



White



1200 x 900 Left Hand - RNG129L

Infinity Slate Tray

Waste included with Tray

Features & Benefits

- Height: 35mm
- Anti-slip surface to DIN Class B
- Solid surface with gel coat finish
- Colour options: White, Black and Grey
- Fully recyclable

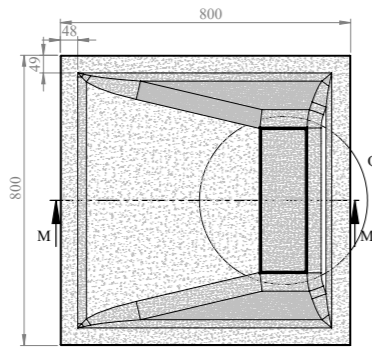
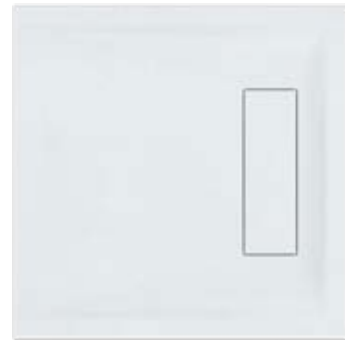

800 x 800 White - IGS80W

Width (mm)	Depth (mm)	Height (mm)	Code
800	800	35	IGS80
1000	800	35	IGS108
1200	800	35	IGS128
1200	900	35	IGS129
1400	800	35	IGS148
1400	900	35	IGS149
1500	800	35	IGS158
1600	800	35	IGS168
1600	900	35	IGS169
1700	800	35	IGS178
1800	800	35	IGS188
Roman Tray Waste - No Cap			RDTW02

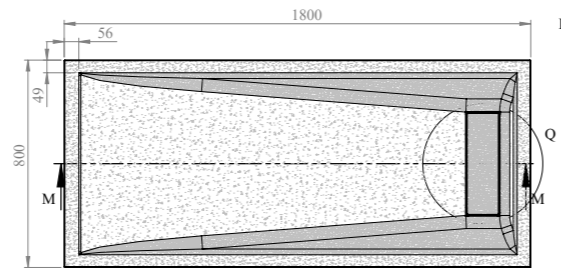

1800 x 800 Black - IGS188B

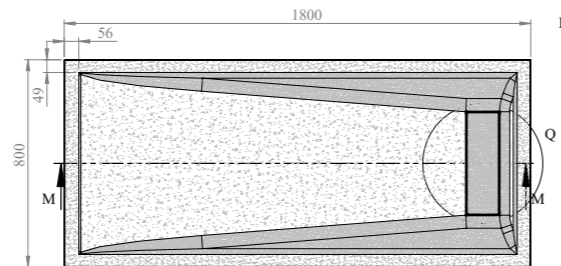

1800 x 800 Grey - IGS188G

Please note: In case of a frameless or a walk-in type of shower enclosure it is normal to see water escaping the tray or splashing outside of the enclosure. You may consider using a fully framed enclosure or a threshold seal on the edges of the shower tray.

Colour options for Infinity Slate Trays

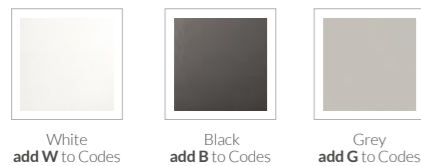

TRUETIME LIFETIME GUARANTEE



1200 x 900 Infinity Slate Tray - Grey - IGS129G

Bath Screens

Collections

Roman's extensive range of Bath Screens allows you to create a stunning contemporary design for over the bath showering, even in the smallest of spaces.

With Roman's all-encompassing Bath Screen collection - over the bath showering doesn't mean you have to compromise on style.

Our range of Bath Screens offers something to suit everyone's requirements and style of bathroom, fitting in both traditional and modern settings.



Liberty Hinged Bath Screen - Matt Black - KLB13B
Shower Basket RSB04B

Liberty Hinged Bath Screen

Features & Benefits

- Hinged from wall
- New clear and minimal seals
- Choice of colour finishes for hardware
- Designed for installation to straight vertical walls
- Optional brace bar included
- Matt Black sandblast finish renders product essentially scratch-proof
- **Power shower approved**

Technical Information

Glass Thickness: 8mm, 10mm

Handing: Reversible

Glass Thickness	Height (mm)	Width (mm)	Adjustment (mm)	Code
8mm	1500	805	N/A	KLB13
10mm	1500	805	N/A	TLB13

Colour options for hardware



Polished Chrome
add **S** to Codes

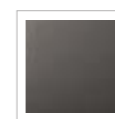

Matt Black
add **B** to Codes

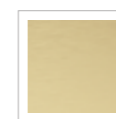

Brushed Brass
add **BR** to Codes



Brushed Nickel
add **N** to Codes

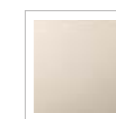

Polished Nickel
add **PN** to Codes



Liberty

Hinged In-Line Bath Screen

Features & Benefits

- Hinged from In-Line Panel
- New clear and minimal seals
- New minimal easy fix wall profile system
- Designed for installation to straight vertical walls
- Optional brace bars included
- Matt Black sandblast finish renders product essentially scratch-proof
- **Power shower approved**

Technical Information

Glass Thickness: 8mm, 10mm

Total Height: 1500mm

Handing: Reversible

Glass Thickness	Height (mm)	Width (mm)	Adjustment (mm)	Code
8mm	1500	1011	998 - 1012	KLVB13
10mm	1500	1011	998 - 1012	TLBV13

Colour options for hardware



Polished Chrome
add **S** to Codes



Matt Black
add **B** to Codes

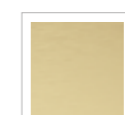

Brushed Brass
add **BR** to Codes

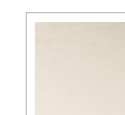

Brushed Nickel
add **N** to Codes

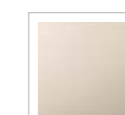

Polished Nickel
add **PN** to Codes

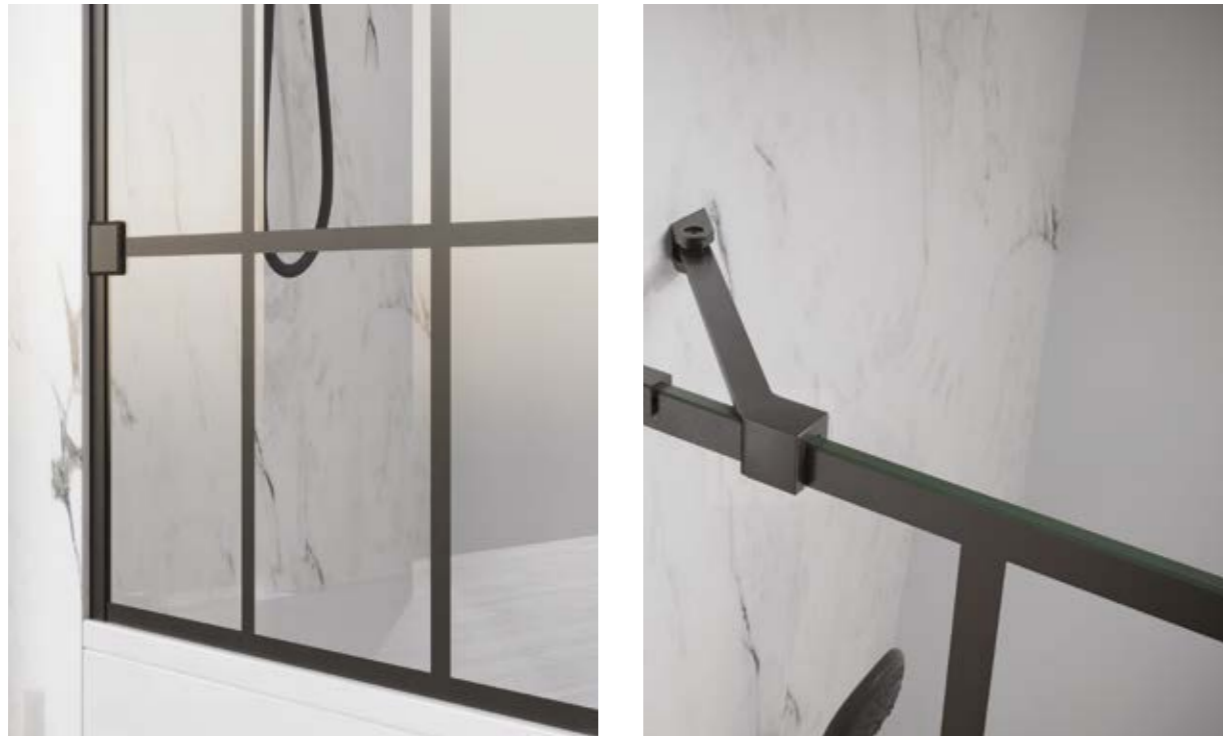

Liberty *Black Grid Fixed Bath Screen*

Features & Benefits

- Glass filled paint fired into the glass during toughening
- New minimal easy fix wall profile system
- Designed for installation to straight vertical walls
- Optional brace bar included
- Matt Black sandblast finish renders product essentially scratch-proof
- **Power shower approved**

Technical Information

Glass Thickness: 10mm

Total Height: 1500mm

Handing: Reversible

Glass Thickness (mm)	Height (mm)	Width (mm)	Adjustment (mm)	Code
10mm	1500	800	N/A	KLBSGPB

Colour options for hardware

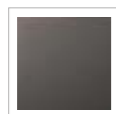

Matt Black

Please note: All colours available on request.



Liberty Black Grid Fixed Bath Screen - KLBSGPB
Shower Basket RSB07B



Innov8 Hinged Bath Screen - Polished Chrome - N2BV213S



Innov8 Hinged Bath Screen - Matt Black - N2BV213B

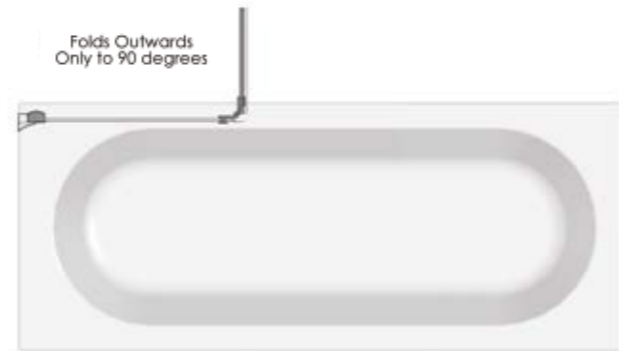
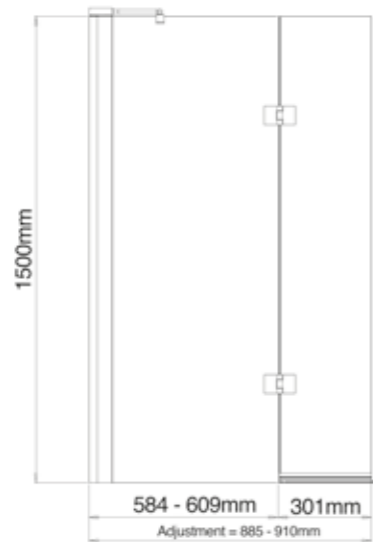

Innov8 Hinged Bath Screen

Features & Benefits

- Outward opening (hinges lock at 90° to avoid contact with basins and furniture)
- Optional Bracing Bar included
- Bath top aluminium seal for added water integrity
- Can be clean from outside
- Matt Black sandblast finish renders product essentially scratch-proof

- Power shower approved

Technical Information

Glass Thickness: 8mm

Total Height: 1500mm

Handing: Left or Right handing must be specified when ordering

Glass Thickness	Height (mm)	Width (mm)	Adjustment (mm)	Code*
8mm	1500	910	890 - 910	N2BV213

*Please note: Handing side must be specified for the correct codes to be ordered. Then add L for left hand, add R for right hand at the end of code.

Colour options for hardware

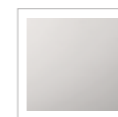

Polished Chrome
add S to Codes

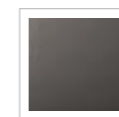

Matt Black
add B to Codes



Brushed Brass
add BBR to Codes

Innov8

Framed Fixed Bath Screen

Features & Benefits

- Back to wall or ceiling brace options
- Fully framed in choice of colour
- Matt Black sandblast finish renders product essentially scratch-proof
- Power shower approved

Technical Information

Glass Thickness: 8mm

Total Height: 1500mm

Handing: Reversible

Colour options for hardware



Polished Chrome
add **S** to Codes



Matt Black
add **B** to Codes

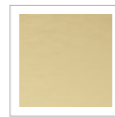

Brushed Brass
add **BBR** to Codes

Glass	Size (mm)	Adjustment (mm)	Code
Clear	1500x800	785 - 810	NBF158
Fluted	1500x800	785 - 810	NBF158F

Description	Size (mm)	Adjustment (mm)	Code Add B or BBR
Back to Wall Brace Kit	1030	Cut to suit	NBBK90SQ
Ceiling Brace Kit	1030	Cut to suit	NBBKC50SQ



Innov8 Framed Fixed Bath Screen with Fluted Glass - NBF158FB
Back to Wall Brace Kit NBBK90SQB



Innov8 Inward Folding Bath Screen - N2BV13BL
Shower Basket RSB02

Innov8

Inward Folding Bath Screen

Features & Benefits

- Vertical adjustment: 20mm
- Horizontal PVC seal and vertical magnetic seals
- Inward opening only
- Fixed panel and hinged screen
- Bath top aluminium seal for added water integrity
- Matt Black sandblast finish renders product essentially scratch-proof
- Power shower approved

Technical Information

Glass Thickness: 8mm

Total Height: 1500mm

Handing: Left or Right handing must be specified when ordering

Size (mm)	Adjustment (mm)	Code*
1500 x 900	880 - 900	N2BV13

*Please note: Handing side must be specified for the correct codes to be ordered. Then add **L** for left hand, add **R** for right hand at the end of code.

Colour options for hardware

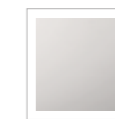

Polished Chrome
add **S** to Codes



Matt Black
add **B** to Codes



Code: EB13S

Embrace *Standard Pivoting Bath Screen*

Features & Benefits

- Matt Black or Polished Chrome frame
- Unique sealing system between vertical and horizontal aluminium
- Power shower approved

Technical Information

Glass Thickness: 6mm
Handing: Reversible

Size (mm)	Colour	Adjustment (mm)	Code
1500x820	Polished Chrome	810 - 835	EB13S
1500x820	Matt Black	810 - 835	EB13B



Code: V8CC113S

Lumin8 *Mini Fixed Bath Screen*

Features & Benefits

- Polished Chrome frame
- Suitable for all standard bath mixer and electric showers
- To be used in conjunction with shower curtains (no hooks or curtain supplied)

Technical Information

Glass Thickness: 8mm
Handing: Reversible

Description	Adjustment (mm)	Code
Mini-Fixed Panel	243 - 257	V8CC113S
Mini-Fixed Panel with Curtain Rail	243 - 257	V8CC213S



Code: EB13B



Code: EBGPB

Embrace *Black Grid Pivoting Bath Screen*

Features & Benefits

- Glass filled paint fired into the glass during toughening
- Glass filled paint fired into the glass during toughening
- Unique sealing system between vertical and horizontal aluminium
- Matt Black sandblast finish renders product essentially scratch-proof
- Power shower approved

Technical Information

Glass Thickness: 6mm
Handing: Reversible

Size (mm)	Adjustment (mm)	Code
1500x820	810 - 835	EBGPB

Please note: All colours available on request.



Code: H4D11CS

Haven8 Fixed Bath Screen

Features & Benefits

- Polished Chrome or Matt Black frame
- Brace bar included
- Unique sealing system for added water integrity
- **Power shower approved**

Technical Information

- Glass Thickness:** 8mm
- Handing:** Reversible

Size (mm)	Colour	Adjustment (mm)	Code
1467 x 800	Polished Chrome	783 - 808	H4D11CS
1467 x 800	Matt Black	783 - 808	V8BS13B



Code: H4D12CS

Haven8 Hinged Bath Screen

Features & Benefits

- Polished Chrome frame
- Chromed brass hinges
- Unique sealing system for added water integrity
- **Power shower approved**

Technical Information

- Glass Thickness:** 8mm
- Handing:** Left or right handing must be specified

Size (mm)	Opening	Adjustment (mm)	Code*
1500 x 835	Outward	810 - 835	H4D12CS

*Please note: Add **L** for left hand, add **R** for right hand at the end of code.



Code: H2D6CS

• Power shower approved

Haven6 Inward Folding Bath Screen

Features & Benefits

- Matt Black or Polished Chrome frame
- Brace bar included
- Unique sealing system for added water integrity
- Matt Black sandblast finish renders product essentially scratch-proof

Technical Information

- Glass Thickness:** 6mm
- Handing:** Reversible

Description	Size (mm)	Adjustment (mm)	Code, add S or B
Inward Folding	1500 x 910	885 - 910	H2D6C
Over-Width Inward Folding	1500 x 975	950 - 975	H2D8C



Code: H2D9CS

Haven6 Curved Inward Folding Bath Screen

Features & Benefits

- Polished Chrome frame
- Frameless with curved glass
- Optional brace bar included
- **Power shower approved**

Technical Information

- Glass Thickness:** 6mm
- Handing:** Left or right handing must be specified

Size (mm)	Adjustment (mm)	Code*
1500 x 910	885 - 910	H2D9CS

*Please note: Add **L** for left hand, add **R** for right hand at the end of code.



Code: H4D3CS

Haven8 Pivoting Bath Screen

Features & Benefits

- Matt Black, Polished Chrome or Brushed Brass frame
- Rotates through 180° for access
- Unique seal system
- Matt Black sandblast finish renders product essentially scratch-proof
- **Power shower approved**

Technical Information

- Glass Thickness:** 8mm
- Handing:** Reversible

Size (mm)	Adjustment (mm)	Code, add S, B or BR
1500 x 835	810 - 835	H4D3C



Code: H4D6CS

Haven8 Inward Folding Bath Screen

Features & Benefits

- Matt Black or Polished Chrome frame
- Inward folding panel
- Unique seal system
- Matt Black sandblast finish renders product essentially scratch-proof
- **Power shower approved**

Technical Information

- Glass Thickness:** 8mm
- Handing:** Reversible

Size (mm)	Colour	Adjustment (mm)	Code
1500 x 910	Polished Chrome	885 - 910	H4D6CS
1500 x 910	Matt Black	885 - 910	V8BV13B



Code: H2D10CBR

Haven6 Power Shower Pivoting Bath Screen

Features & Benefits

- Matt Black, Polished Chrome or Brushed Brass frame
- Rotates through 180° for access
- Unique sealing system for added water integrity
- Matt Black sandblast finish renders product essentially scratch-proof
- **Power shower approved**

Technical Information

- Glass Thickness:** 6mm
- Handing:** Reversible

Size (mm)	Colour	Adjustment (mm)	Code
1500 x 815	Polished Chrome	810 - 825	H2D10CS
1500 x 815	Matt Black	810 - 825	H2D10CB
1500 x 815	Brushed Brass	810 - 825	H2D10CBR



Code: H2D1CS

Haven6 Angled Pivoting Bath Screen with Towel Handle

- | | |
|--|---|
| Features & Benefits | Technical Information |
| <ul style="list-style-type: none"> Polished Chrome frame Suitable for all standard bath mixer and electric showers Not recommended for use with pumped or pressurised systems | <ul style="list-style-type: none"> Glass Thickness: 6mm Handing: Reversible |

Size (mm)	Adjustment (mm)	Code
1500 x 850	850 - 875	H2D1CS



Code: H2D2CS

Haven6 Curved Pivoting Bath Screen

- | | |
|---|---|
| Features & Benefits | Technical Information |
| <ul style="list-style-type: none"> Polished Chrome frame Rotates through 180° for access Suitable for all standard bath mixer and electric showers | <ul style="list-style-type: none"> Glass Thickness: 5mm Handing: Reversible |

Description	Size (mm)	Adjustment (mm)	Code
Curved Bath Screen	1360 x 820	810 - 825	H2D2CS
Supplementary Sealing Kit	-	-	BSP001



Code: H2D3CS

Haven6 Standard Pivoting Bath Screen

- | | |
|--|---|
| Features & Benefits | Technical Information |
| <ul style="list-style-type: none"> Polished Chrome frame Rotates through 180° for access Frameless with square glass Suitable for all standard bath mixer and electric showers | <ul style="list-style-type: none"> Glass Thickness: 5mm Handing: Reversible |

Description	Size (mm)	Adjustment (mm)	Code
Standard Bath Screen	1360 x 820	810 - 825	H2D3CS
Supplementary Sealing Kit	-	-	BSP001



Code: H2D11CB

Haven6 Fixed Bath Screen

- | | |
|---|---|
| Features & Benefits | Technical Information |
| <ul style="list-style-type: none"> Matt Black or Polished Chrome frame Brace bar included Unique sealing system for added water integrity Power shower approved | <ul style="list-style-type: none"> Glass Thickness: 6mm Handing: Reversible |

Size (mm)	Colour	Adjustment (mm)	Code
1467 x 800	Polished Chrome	787 - 812	H2D11CS
1467 x 800	Matt Black	787 - 812	H2D11CB



Vanity Units Rectangle Basin

Description	Handing	Width (mm)	Height (mm)	Depth (mm)	Code
600 Rectangular Basin	-	600	160	510	RFA0054
800 Rectangular Basin	Left Hand	800	160	510	RFA0059
800 Rectangular Basin	Right Hand	800	160	510	RFA0063



Vanity Units Oval Basin

Description	Handing	Width (mm)	Height (mm)	Depth (mm)	Code
600 Oval Basin	-	600	160	510	RFA0052
800 Oval Basin	Left Hand	800	160	510	RFA0057
800 Oval Basin	Right Hand	800	160	510	RFA0061



Vanity Units Rectangle Basin with Frame

Description	Handing	Width (mm)	Height (mm)	Depth (mm)	Code
600 Rectangular Basin-Metal	-	600	530	510	RFA0055
800 Rectangular Basin-Metal	Left Hand	800	530	510	RFA0060
800 Rectangular Basin-Metal	Right Hand	800	530	510	RFA0064



Vanity Units Oval Basin with Frame

Description	Handing	Width (mm)	Height (mm)	Depth (mm)	Code
600 Oval Basin-Metal	-	600	530	510	RFA0053
800 Oval Basin-Metal	Left Hand	800	530	510	RFA0058
800 Oval Basin-Metal	Right Hand	800	530	510	RFA0062



Black Grid Mirrors

Our bold industrial style window mirrors will make a statement in any room. These mirrors encapsulate factory chic with an elegant twist presenting a fabulous accent for the industrial trend. The mirrors feature printed glass and are suitable to be used in any room including bathrooms. The mirrors are made with 6mm safety glass.

Cleaning and care guidance:

Treat them like any other mirrored surface, use a lint free cloth and a purposely manufactured cleaning agent, designed for mirrors. Don't use anything abrasive.

Colour options for hardware

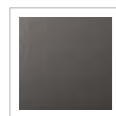

Matt Black

Colour	Size (mm)	Code
Square Black Grid Mirror	950 x 950	MIRO1
Rectangle Black Grid Mirror	800 x 600	MIRO3
Rectangle Black Grid Mirror	700 x 500	MIRO4
Arched Black Grid Mirror	1100 x 750	MIRO2

Double Hanging Basket with Hooks

Spacers supplied so basket can be hung directly onto the glass edge

Width: 220mm

Depth: 125mm

Height: 765mm

Colour Options: Polished Chrome,

Matt Black, Brushed Brass

Image Shown Code: RSB01



Depth (mm)	Width (mm)	Height (mm)	Colour	Code
125	220	765	Polished Chrome	RSB01
125	220	765	Matt Black	RSB01B
125	220	765	Brushed Brass	RSB01BR

Stepped Soap Basket

Width: 260mm

Depth: 131mm

Height: 57 / 29mm

Colour Options: Polished Chrome

Image Shown Code: RSB03

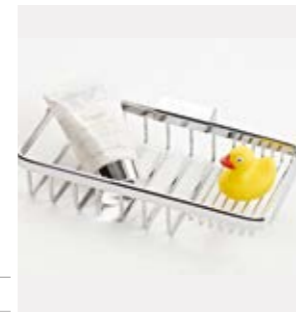

Depth (mm)	Width (mm)	Height (mm)	Code
131	260	57 & 29	RSB03

Large Rectangular Shower Basket

Width: 260mm

Depth: 120mm

Height: 95mm

Colour Options: Polished Chrome

Image Shown Code: RSB06

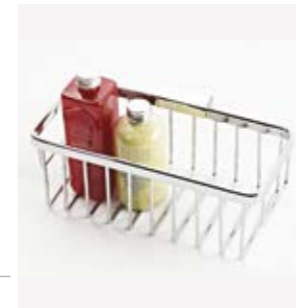

Depth (mm)	Width (mm)	Height (mm)	Code
120	260	95	RSB06

Double Corner Shower Basket with Hooks

Width: 293mm

Depth: 224mm

Height: 399mm

Colour Options: Polished Chrome,

Matt Black, Brushed Brass

Image Shown Code: RSB05



Depth (mm)	Width (mm)	Height (mm)	Colour	Code
224	293	399	Polished Chrome	RSB05
224	293	399	Matt Black	RSB05B
224	293	399	Brushed Brass	RSB05BR

Large Curved Corner Basket

Width: 296mm

Depth: 224mm

Height: 73mm

Colour Options: Polished Chrome,

Matt Black, Brushed Brass

Image Shown Code: RSB02BR



Depth (mm)	Width (mm)	Height (mm)	Colour	Code
224	296	73	Polished Chrome	RSB02
224	296	73	Matt Black	RSB02B
224	296	73	Brushed Brass	RSB02BR

Large 'L' Shaped Corner Shower Basket

Width: 255 / 270mm

Depth: 115 / 125mm

Height: 99mm

Colour Options: Polished Chrome

Image Shown Code: RSB04



Depth (mm)	Width (mm)	Height (mm)	Code
115/125	255/270	99	RSB04

Roman Shower Blade (includes spare blade part)

Colour Options: Polished Chrome,

Matt Black, Brushed Brass

Image Shown Code: RSB0100

Colour	Code
Polished Chrome	RSB0100
Matt Black	RSB0100B
Brushed Brass	RSB0100BR



Double Rectangular 'single wall' Shower Basket with Hooks

Width: 215mm

Depth: 106mm

Height: 391mm

Colour Options: Polished Chrome,

Matt Black, Brushed Brass

Image Shown Code: RSB07



Depth (mm)	Width (mm)	Height (mm)	Colour	Code
106	215	391	Polished Chrome	RSB07
106	215	391	Matt Black	RSB07B
106	215	391	Brushed Brass	RSB07BR



HOTEL & PROJECTS

Roman's International team work closely with distribution and retail partners all over the world. The team has worked on a number of diverse Hotel, Residential & Hospitality Projects, which have been undertaken in a variety of different countries.



OTHER BRANDS



SUSTAINABILITY & TESTING

All Roman products meet and exceed approved testing standards. A key facet of sustainability is an adherence to these standards. The use of substandard materials means they will fail and need to be replaced.



ALUMINIUM & BRASS
100% of Roman aluminium is recycled material.



CARBON NEUTRAL
Roman achieved carbon neutral certification from the Carbon Trust in 2021.



CIRCULAR ECONOMY
Roman's sustainable supply chain focuses on recycling before and after the life of the product.



GLASS
80% of Roman glass is recycled material.



ISO
Introducing the concept of measurement into every process for sustainable manufacturing



MADE IN BRITAIN
All Roman products are proudly Made in Britain.

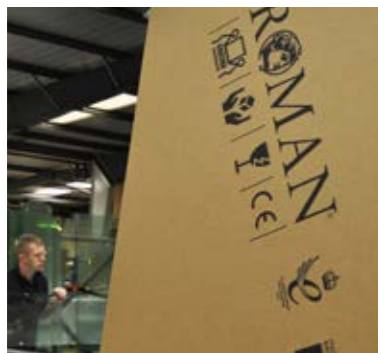

PACKAGING
All packaging is manufactured from recycled corrugated cardboard.



TRAYS
Re-used back to its original value at the end of life.



UNGC
Roman is a committed member of the United Nations Global Compact and their sustainable development goals.



ENDURANCE TEST
The shower door is open and closed on a 20,000 cycle to ensure endurance.



WATER RETENTION TEST
High pressure shower is directed at the door to ensure there's no leakage.

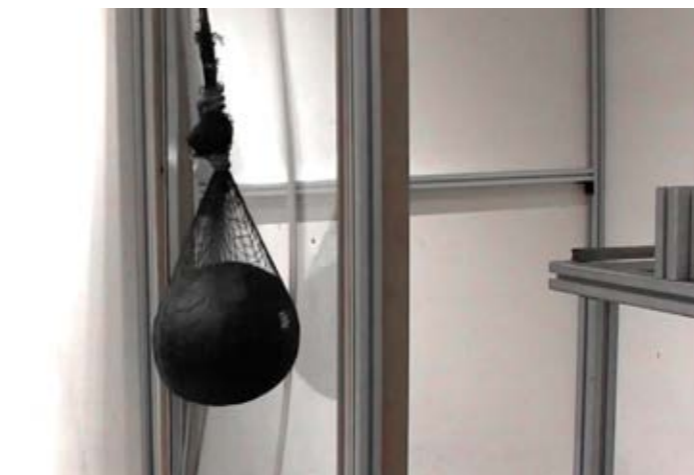

STRUCTURAL STABILITY TEST
A ball up to the weight of 50kg is launched into the enclosure to ensure rigidity if there is a fall.



PRODUCT TRACEABILITY
Roman take digital photographs of each product in production and each box has a unique code for 10 years.

Roman's Bespoke Service allows you to build a made to measure Shower Enclosure, Wetroom Panel or Bath Screen, to perfectly suit your available space.

Send us your showering area and ideas and we can help you create a unique environment for yourself.



- Made to measure items which fit almost anywhere
- All products made in accordance with your own measurements
- We endeavour to provide fast and efficient answers to all your questions
- Cost effective solutions
- Many designs to suit all tastes
- Measure and fit service available

Bespoke Services available:

- Reduced height
- Reduced width
- Clear, frosted or printed glass
- Angled/Shaped glass

To order a Bespoke Service all you have to do is simply choose which product you would like, then follow these six easy steps:

1. Take your drawings to your nearest retailer who will fax them to Roman. For your nearest retailer contact Roman Customer Relations on 01325 328033 or visit www.roman-showers.com
2. Roman will then send a quotation to your retailer for them to discuss with you
3. If you are happy with this quotation Roman will produce a drawing to illustrate what your final product will look like. Note: Roman will make all drawings in accordance to your measurements and unless otherwise requested, an adjustment allowance will be included. Please specify your adjustment allowance prior to ordering.
4. Roman will then fax the drawing to your retailer who will pass this on to you. This drawing will be in the form of a fax back agreement for you to sign*.
5. Once Roman receives the agreement work will begin on your product.
6. You will receive your product within 5-6 weeks.

*Once this agreement is signed you will be liable for any changes should you cancel your order.

Consumer Guide

Roman shower enclosures have been tested and fully conform to the scope and relevant characteristics of BS EN14428:2015 (Shower Enclosures - Functional requirements and test methods), to meet the requirements of the mandate given under the EU Construction Product Directive (89/106/EEC).

As a result of full compliance to the directive and harmonized standard; Roman shower enclosures carry the 'CE' mark and are accompanied by a declaration of performance. (Available to view on www.roman-showers.com)

The CE marking indicates Roman shower enclosures conform to all essential requirements of European health and safety and environmental protection legislation. The conformity is mandatory, and allows Roman products to be legally placed on the market anywhere in the European Economic Area.

Any newly manufactured products from the 1st January 2021 will have the new UKCA mark applied as per government guidelines.

The UKCA (UK Conformity Assessed) marking is a new UK product marking that will be used for goods being placed on the market in Great Britain (England, Wales and Scotland). It covers most goods which previously required the CE marking.

Please note: this will only apply to any new products manufactured from 1st January 2021, any products held in stock will still be able to display the CE mark.

Additionally all Roman trays fully conform to EN14527:2016.



Important Product Details

- Enclosures and screens carry a Lifetime manufacturer's guarantee if products are installed according to the installation instructions - see guarantee criteria to the right.
- Simple and clear installation instructions are included with all Roman Products.
- Roman products are available for Virtual Worlds design service. For more information contact Roman Customer Relations on 01325 328033.
- Any guarantee variations are indicated separately.
- All guarantee forms supplied with installation instructions must be completed and returned to Roman within 60 days to validate the lifetime guarantee otherwise only a statutory 12 month guarantee will apply.
- All Roman Bath Screens and Enclosures are manufactured using toughened safety glass which complies to BSEN12150.
- All Roman Bath Screens and Enclosures are tested in accordance with BSEN14428 - shower enclosures, functional requirements and test methods.
- Roman's toughened glass is completely safe for use in our shower enclosures and bath screens; providing our products are installed according to our guidelines.
- It is important to note, that the glass must not be mounted or 'pinched' in such a way that would cause a stress point to develop in the glass. In addition, it must not be subjected to any sharp impact or severe temperature fluctuation which may also cause a stress point to develop in the glass.
- Roman's toughened glass is physically and thermally significantly stronger than standard glass. However a significant impact (or stress as outlined above) can cause toughened glass to break. In the event of breakage, toughened glass will break safely into small fragments in line with all relevant standards.
- All heights quoted for enclosures and bath screens are from the top of the shower tray or bath.
- All fixings are hidden on Roman products.
- The term "Silver" and "Nickel" describes the colour of the aluminium finish. No silver metal is included in any Roman products.
- All fixings and pivot pins are manufactured from stainless steel - this adds great strength and durability to Roman products.
- All seals and gaskets on Roman products are manufactured from colourless PVC.
- Roman over-bath products are not designed for baths with shaped or stepped fronts or integral soap dishes.
- The design rights of these products are owned by Roman Limited. All rights reserved.
- Roman recommends only the use of Roman Trays with Roman Shower Enclosures.
- For compatibility of Roman enclosures with steam generators please contact Roman Customer Relations for advice on 01325 328033.
- Where indicated that products are suitable for use with steam generators, this refers to the performance of the product components. We do not however suggest that the product will have complete steam integrity.
- Due to the nature of wetroom panel products, water integrity cannot be guaranteed. Please consult your installer.
- We make every effort to ensure that your product reaches you in perfect condition. However, please be advised that all toughened glass panels are not covered by our guarantee if installed incorrectly or are subject to misuse. Roman's toughened glass is physically and thermally stronger than standard glass. However any significant impact may cause the glass to shatter in as safe a manner as possible and in accordance with the British and European standard (BSEN14428).

Guarantee

Roman Ltd. guarantees all Shower Enclosures, Bath Screens and Roman Solid Surface Trays against faulty materials or manufacture for LIFE, provided they have been installed, used and maintained in accordance with our instructions. All Roman product guarantees must be completed and returned within 60 days of purchase to validate the relevant guarantee. Failure to meet this deadline will result in a statutory 1 year guarantee on all products.

Should a claim arise, Roman Ltd. Customer Relations will investigate the issue. As part of this investigation we request that the following conditions be satisfied:

1. Proof of purchase at the time of the claim.
2. The guarantee applies to the original purchaser only and is non transferable.
3. The product has been fitted/installed in accordance with Roman Ltd. fixing instructions, local bylaws and general good plumbing practice
4. The product has been maintained and cared for in accordance with our instructions (including regular and appropriate cleaning).

If in our opinion the product has been modified, misused, neglected, wilfully or accidentally damaged, we can accept no responsibility for failure. Roman Ltd. or its representatives must be given the opportunity to inspect the product in the installed condition. Callouts may be chargeable depending upon circumstances. Should any products included in the Lifetime guarantee be used for Commercial use i.e. leisure clubs, schools, hospitals, student accommodation, hotels or residential homes, only a 5 year guarantee will be applicable.

If in our opinion the product fails due to faulty materials or manufacture and that the conditions above have been met, Roman Ltd. will arrange for a specialist Roman Technical Sales Representative to repair or replace that item at our option.

Roman Ltd. believes in continuous improvement. If in our opinion the product has failed under the terms of the Guarantee and a replacement is offered but identical goods are no longer available, Roman Ltd. will endeavour to replace it with our nearest equivalent product. For countries outside of the UK and Republic of Ireland, where a product has failed due to faulty materials or manufacture, a replacement product or product part will be offered only.

Should Roman Ltd. carry out work as a result of a claim but subsequently it is revealed that the product has been abused or improperly installed, we reserve the right to charge the customer for the expense incurred.

The liability of Roman Ltd. is limited to the product supplied by Roman Ltd. and does not extend to consequential loss or damage arising from the defective product. This Guarantee, which is effective for products purchased after February 1st 2006, states our entire liability and is offered to customers acquiring our products as consumers, not in the course of trade or business. Ex displays or products reinstalled from their original position are not covered under this guarantee.

Non glass or metallic parts (e.g. seals) are subject to normal wear and tear through usage and are therefore covered on all products for 1 year from installation. Roman products not included in the Lifetime Guarantee are Roman Acrylic Trays which are covered for 1 year.

Roman Ultra Care pre-coat is not covered by this guarantee and it must be maintained by applying Ultra Care from a bottle on an ongoing basis.

Commercial projects with specific guarantee requirements can be subject to negotiation and agreement on a project by project basis. Any such agreements must be confirmed in writing prior to product supply or commencement in project works.

This guarantee does not affect your statutory rights. This guarantee is wholly applicable in the U.K. and Republic of Ireland – export conditions as indicated

Roman Ltd
Whitworth Avenue, Aycliffe Business Park,
County Durham, DL5 6YN
Tel: 01325 311318 Fax: 01325 319889
www.roman-showers.com



ROMAN HEAD OFFICE

Whitworth Avenue,
Aycliffe Business Park,
County Durham,
DL5 6YN,
England, UK.

GENERAL RECEPTION

Phone: +44 (0) 1325 311318
UK CUSTOMER RELATIONS:
Phone: +44 (0) 1325 328033
Email: custserv@roman-showers.com

UK SALES

Phone: +44 (0) 1325 328034
Email: orders@roman-showers.com

INTERNATIONAL SALES/CUSTOMER RELATIONS

Phone: +44 (0) 1325 327740
Email: international@roman-showers.com
www.roman-showers.com/international

ROMAN - IRELAND

W10F
Ladytown Business Park
Naas
County Kildare
Ireland
Phone: +353 (0) 45 408 118
Email: irelandsales@roman-showers.com

ROMAN - ASIA PACIFIC

Roman Asia Sdn Bhd (941603-K)
No.6, Jalan Olivin, Taman Industri Sungai
Purun,
43500 Semenyih, Selangor, Malaysia.
Phone: +60 (0) 3 8727 8816
Email: romanasia@roman-showers.com